

emco

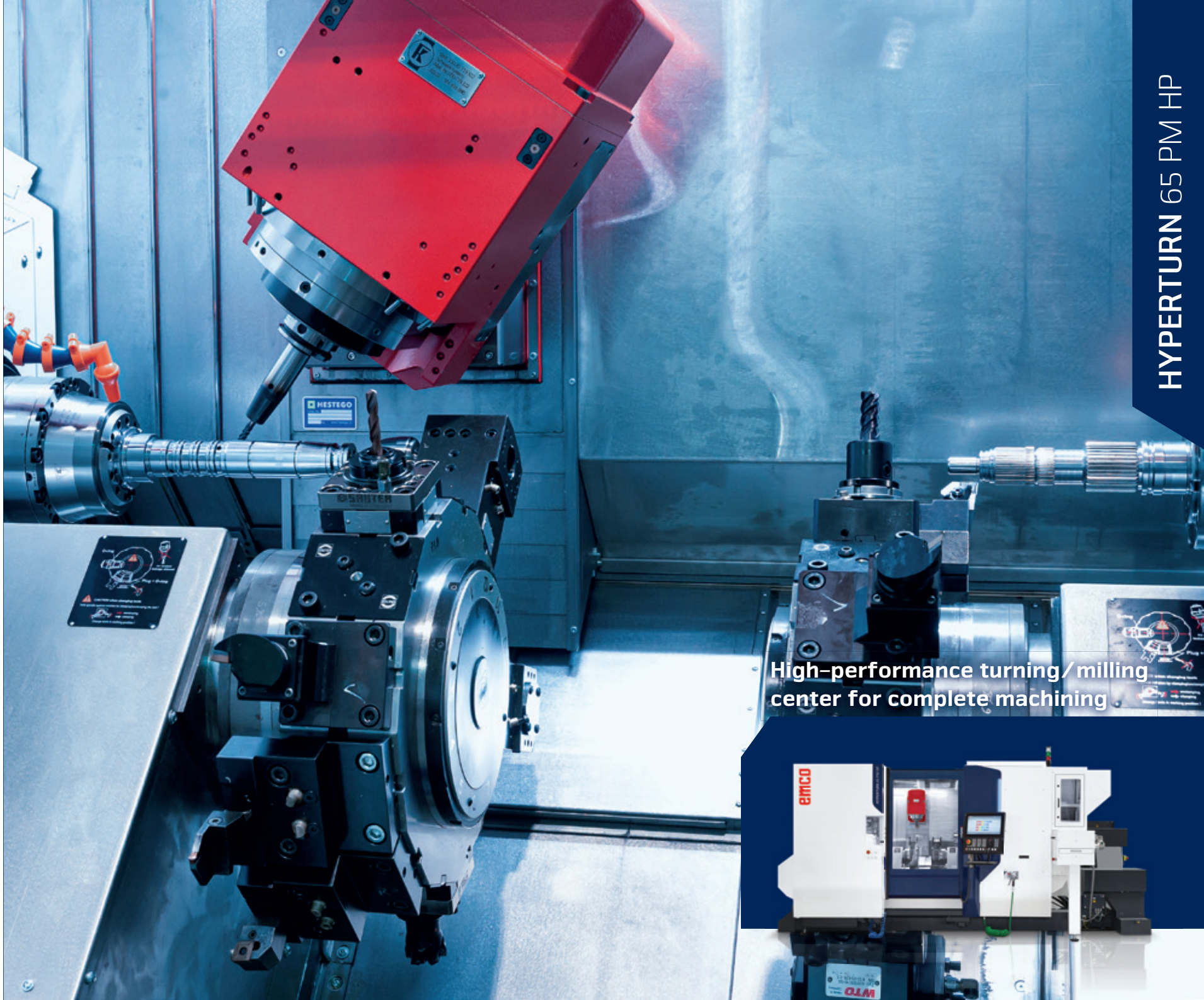

High-performance turning / milling center for complete machining

HYPERTURN 65 PM HP



TURNING/MILLING CENTER FOR MAXIMUM PRODUCTIVITY AND FLEXIBILITY

Equipped with two turning spindles, a powerful milling spindle including a tool changer and a 40-slot magazine as well as with two lower tool turrets featuring 12 or 16 driven positions each, the new HYPERTURN 65 Powermill HP (HIGH PERFORMANCE) allows for maximum productivity, especially when it comes to the efficient production of small and medium-sized series with a high degree of variance.

- 1 MAIN SPINDLE**
 - / Water-cooled Integrated Spindle Motor (ISM) in synchronous technology
 - / High drive power 29 (29/37) kW
 - / High torque 250 (250/360) Nm
 - / Large speed range 0 - 5000 (4000/3500) rpm
 - / Highly dynamic
 - / Bar capacity diameter 65 (76/95) mm
- 2 UPPER TOOL SYSTEM**
 - / Powerful milling spindle 22 kW
 - / Wide speed range 0-12000 rpm
 - / Water-cooled motor spindle with HSK-T63
 - / Internal and external coolant supply
- 3 B-AXIS**
 - / Direct drive with torque motor
 - / Can be clamped in any position within a range of +/- 110°
 - / 5-axis interpolation
- 4 UPPER Y-AXIS**
 - / Large working stroke +120 / -100
 - / Short projection length
 - / Pre-loaded roller guides
 - / Wide guide clearance
- 5 TOOL MAGAZINE**
 - / 40/80-slot chain-type tool magazine
 - / Ergonomically arranged at the front
 - / Easy to be manually loaded with tooling
 - / Max. tool length 250 mm
 - / Max. tool diameter 80 (120) mm
 - / Max. tool weight 5 kg
- 6 COUNTER SPINDLE**
 - / Water-cooled Integrated Spindle Motor (ISM) in synchronous technology
 - / High drive power 29 (29/29) kW
 - / High torque 250 (250/250) Nm
 - / Wide speed range 0-5000 rpm
 - / Internal coolant supply for flushing
 - / Automatic part ejector
- 7 LOWER TOOL SYSTEM**
 - / 2x 12-station tool turret
 - / Stable and precise BMT55P (BMT45P) interface
 - / Water-cooled milling drive
 - / Up to 24 (32) driven positions
 - / Synchronized tapping
 - / Polygonal turning
- 8 LOWER Y-AXIS**
 - / Travel +/- 50 mm
 - / Stable, compact construction
 - / Wide guide clearances
 - / Wedge carriage system
- 9 CONTROL UNIT**
 - / Ergonomically designed
 - / 90° swivelling
 - / Height adjustment: 100 mm
 - / Lateral adjustment: 500 mm (option)
 - / Sinumerik ONE
 - / 22" multi-touch display incl. IPC
- 10 CHIP CONVEYER**
 - / Hinged type conveyor belt
 - / Throw-off height 1200 mm
 - / Integrated coolant tank 400 l
 - / Paper-band filtration unit 980 l
 - / 40 bar through milling spindle
 - / 2x 25 bar through tool turrets



Machine with optional equipment

TECHNICAL HIGHLIGHTS

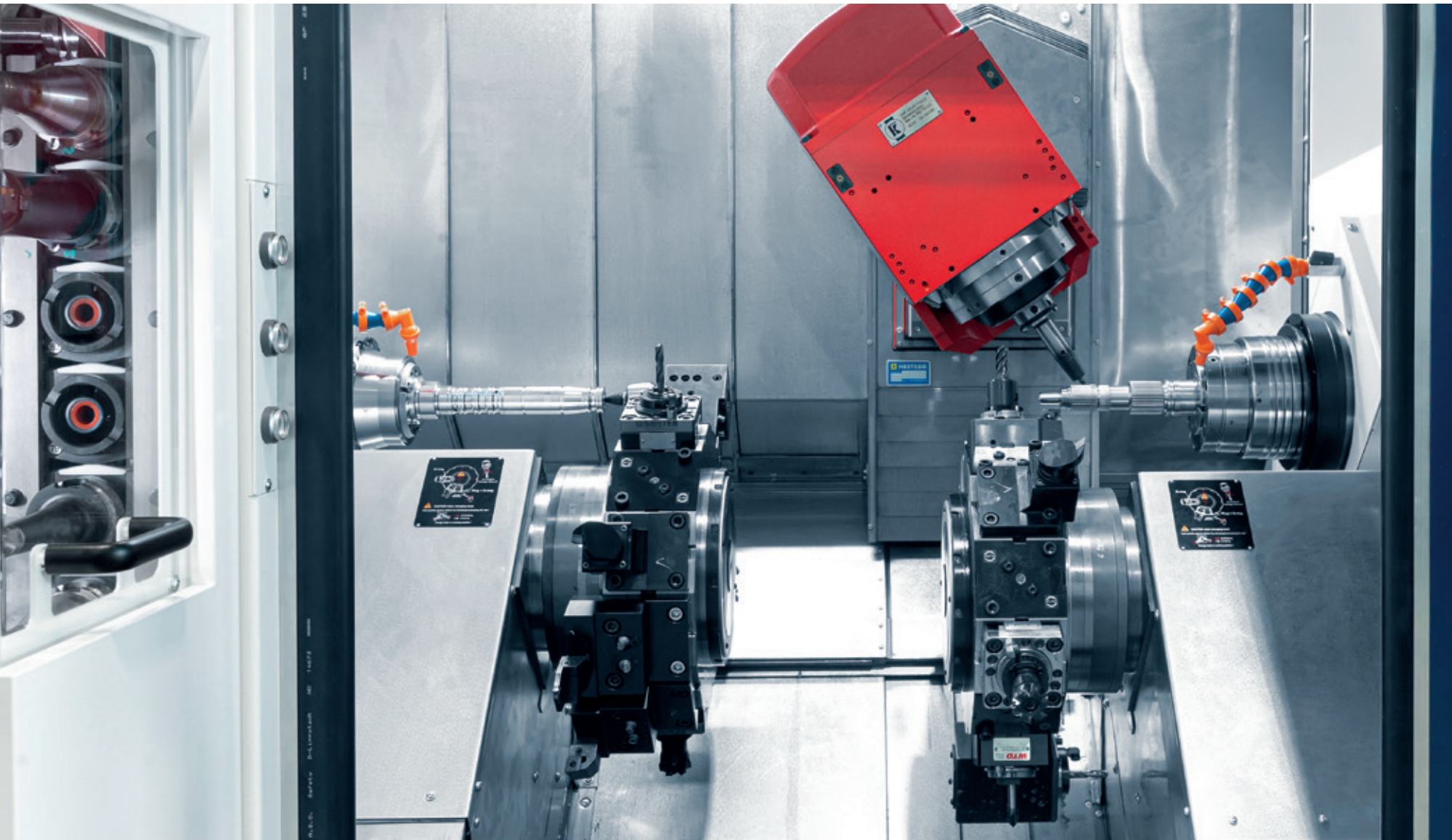

MAIN SPINDLE

With an output of 29 (37) kW and 250 (360) Nm torque, the main spindle is powerful enough to machine from bar-stock up to a diameter of 65 (76/95) mm to chuck parts up to a diameter of 250 mm. A mechanical clamp brake ensures additional stability for high-performance milling.

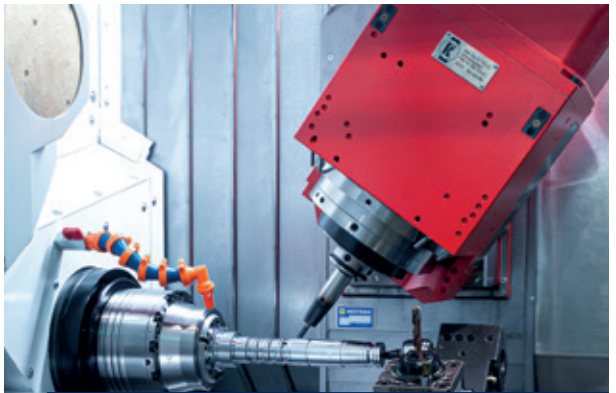

MILLING SPINDLE

At 22 kW and 60 Nm and a max. speed of 12000 rpm, the HYPERTURN 65 Powermill HP supports state-of-the-art milling processes such as HSC or HPC. This means that complex turned and milled parts can be produced in an extremely efficient manner.



MANUAL TOOL CHANGING

Tools can be loaded into the tool magazines from the front. This avoids the need for the user to go to the rear of the machine. Also tool wear or break inspections can be handled in a time-saving way.

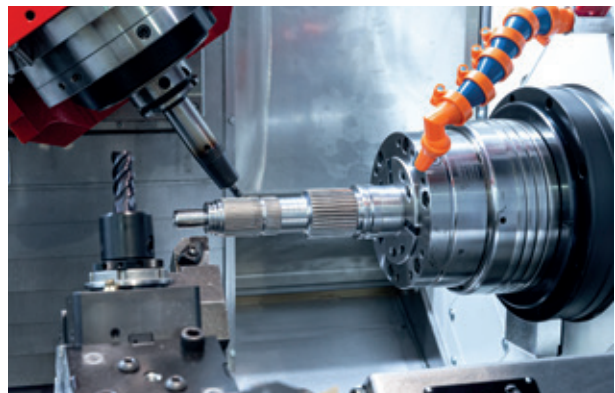

COUNTER SPINDLE

The moving counter spindle offers identical performance data to the main spindle. The mechanical disc brake is also included in the basic equipment level. Additionally, a stroke-monitored part ejector that is flooded with coolant is integrated into the spindle. This ensures a reliable, unmanned machining process.



HOLDING BRAKE ON THE MAIN AND COUNTER SPINDLE

It is always the respective C-axis which is positioned for milling and drilling operations. Additionally, however, it is possible to clamp each spindle in any position.



CONTROL UNIT

On the Hyperturn 65 Powermill HP, the Sinumerik ONE control unit is located on the right side of the work area in a swivelling panel. This ensures maximum ergonomics for setting up and running in the machine.

NETWORKS ARE CREATED INDIVIDUALLY – OUR SOLUTIONS AS WELL



Staying in touch is not only important for people. Staff, machines and the production environment must also be securely networked with each other to ensure an efficient production process. With EMCONNECT, the machine is optimally equipped for this. In addition, EMCONNECT Digital Services provides innovative online services to optimise machine operation. The machine data form the basis for a wide range of applications. In this way, the user has the status of the machine available at any time and in any place.



Integration into the control

EMCONNECT offers options for situation-dependent operation. Apps can also be used in parallel with the control system. With optimal integration into the NC control system, EMCONNECT complements the NC control with powerful functions for modern control generations (SIEMENS, HEIDENHAIN, FANUC). The familiar vision of the machine NC control is maintained at all times.

An innovative concept

These powerful apps may be used independently from the control, while in the background the machine is busy in the production process. With only one click, you can change at any moment between numerical control and EMCONNECT. This is possible with the help of an innovative and ergonomic control panel, equipped with a modern 22" multi-touch display, an industrial PC with associated keyboard and HMI hotkeys.

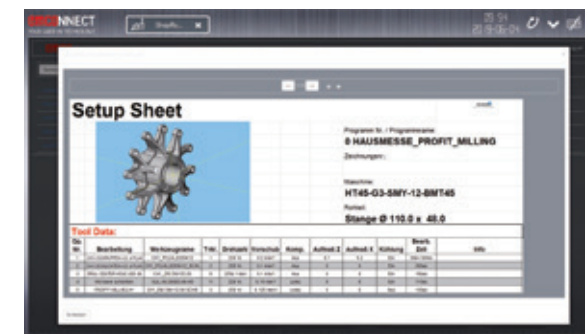

Control panel as central platform

With EMCONNECT, the machine control panel becomes a central platform with access to all necessary applications, data and documents. Remote Support, Web Browser and Remote Desktop offer a wide range of connection options, even outside the direct production environment. The optional OPC UA interface allows data exchange with the IT system environment and interaction with other machines for shop floor automation. In this way, EMCONNECT makes an important contribution to highly efficient machine operation.



Innovative online services

With EMCONNECT Digital Services, all interested users have online access to the current status and evaluations of the machine. Automatic notification in the event of malfunctions or machine stoppages and extended diagnostic options for remote maintenance reduce downtimes and machine downtime to a minimum. Integrated maintenance management supports predictive maintenance based on machine utilisation. Thanks to the continuous development of online services, new functions are always available.

EMCONNECT HIGHLIGHTS AND FUNCTIONS

- / Fully networked**
Remote access to office computers, web browsers and online services with all applications and users connected
- / Structured**
Clear monitoring of the machine state and the production data
- / Customized**
Open platform for modular integration of customer-specific applications
- / Compatible**
Interface for seamless integration into the operating environment
- / User-friendly**
Intuitive and production-optimized touch operation
- / Future-proof**
Continuous extensions as well as easy updates and upgrades

Standard-Apps

Control	Dashboard	Machine Data
System	Maintenance Manager	Digital Services
Remote Desktop	Settings	Web Browser
Remote Support	TeamViewer	Service
Cutting Calculator	Calculator	Notes
Backup & Restore	File Import	Documents
GD&T	EMCO TechSheet	Thread Reference



Optional

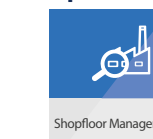



/ Ing. Johann Brisker
Brisker GmbH

"All EMCO turning machines are automated with short bar or bar loaders, which frees up employees for other tasks and, as a consequence, increases productivity."

The EMCO short bar loaders. Universal and powerful.



SHORT AND TO THE POINT.

The EMCO SL1200 is the perfect solution for automatic feeding and loading of cut-to-length bars. The key advantages are a small footprint and rapid loading times resulting from shorter strokes.

The technology. The EMCO SL1200 can be used immediately as a "plug-and-play" solution. Their extremely small footprint enables processes to be automated even if space is tight. Apart from complying with the latest safety requirements, it is easy to operate and

moveable for service purposes. Besides, it can comfortably be incorporated into the production process using the machine control's programme input masks. Minimum setup efforts are required when switching over to other bar diameters.



EMCO SL1200

Space-saving and cost-effective bar loading magazine. Operation and programming could not be easier. May also be used for loading single items through the lathe's main spindle.

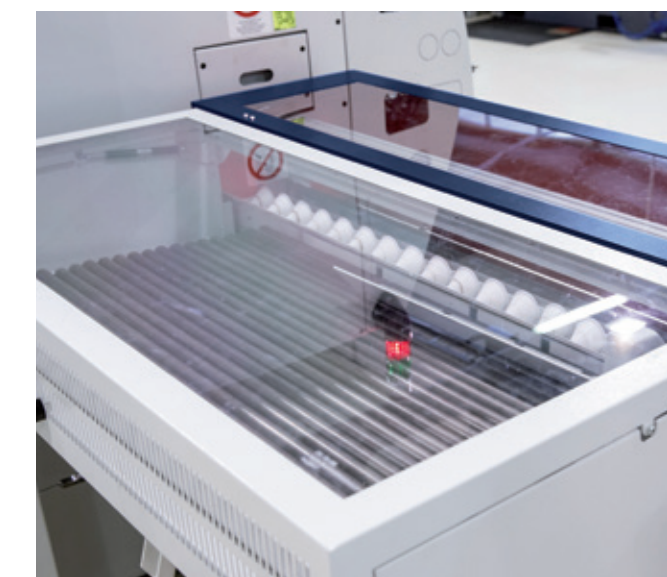

MATERIAL STORAGE

The material storage surface with a length of 560 mm is arranged at the rear of the bar loader in a manner with no influence whatsoever on the space available. Depending on the diameter it is possible to store a different number of short bars.

THE BENEFITS

- / Small footprint
- / Easy to use
- / Short feed times
- / Fast, straightforward changeover
- / Option to load individual workpieces
- / Central diameter adjustment
- / The loader operates without oil
- / Ergonomic EMCO design

Technical data	SL1200
Bar diameter	Ø 8 – 95 mm
Max. bar length	1200 mm
Min. bar length	150 mm
Max. bar weight	45 kg
Material storage length	approx. 560 mm
Feed rate	0 – 60 m/min
Bar change time	approx. 15 sec.
Dimensions (L x W)	1700 x 1250 mm
Weight	approx. 500 kg

INSTALLATION PLAN

Installation plan HT65 PM HP

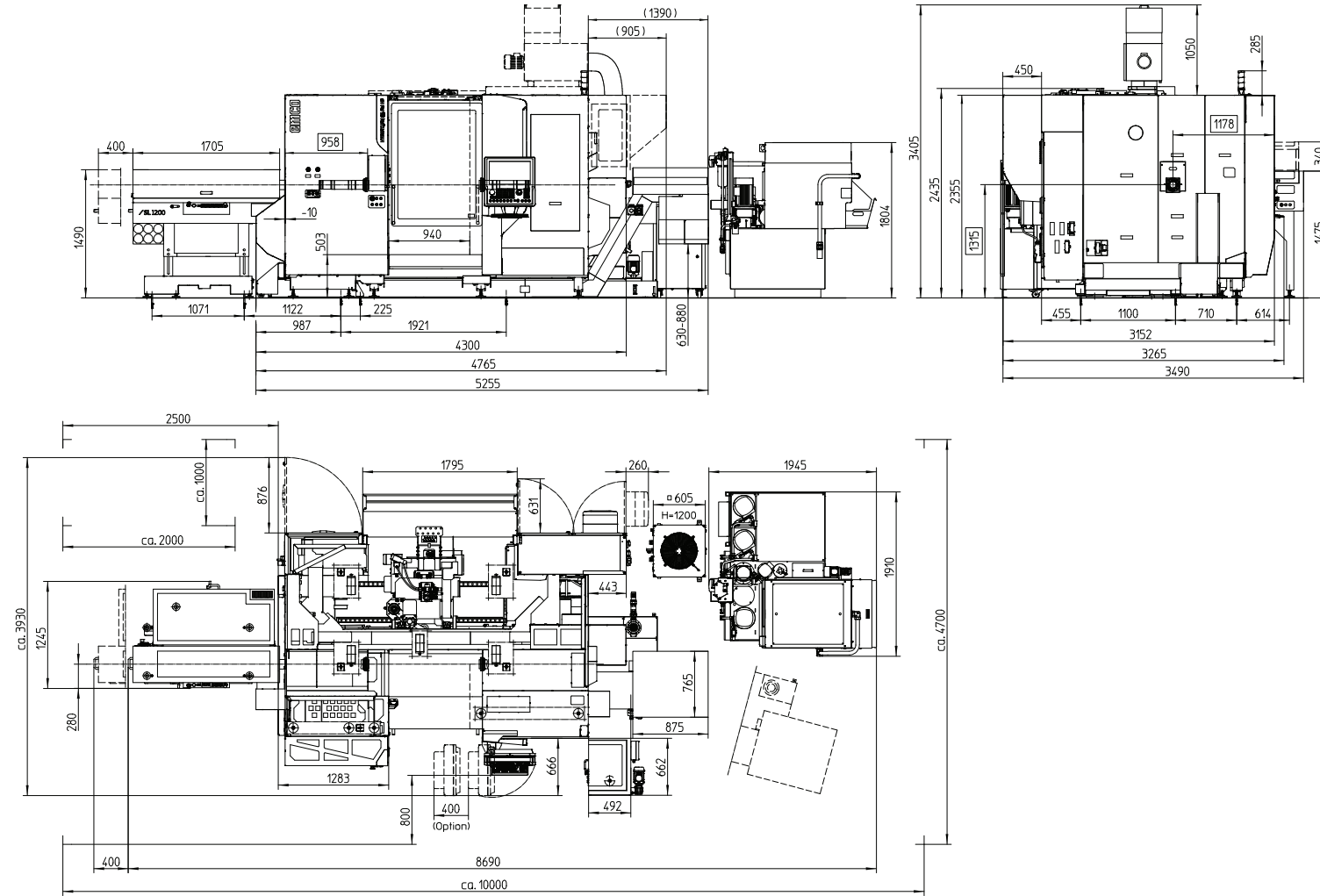

Indications in millimetres

WORK AREA

Working area HT 65 PM HP with 12-position BMT55P turret

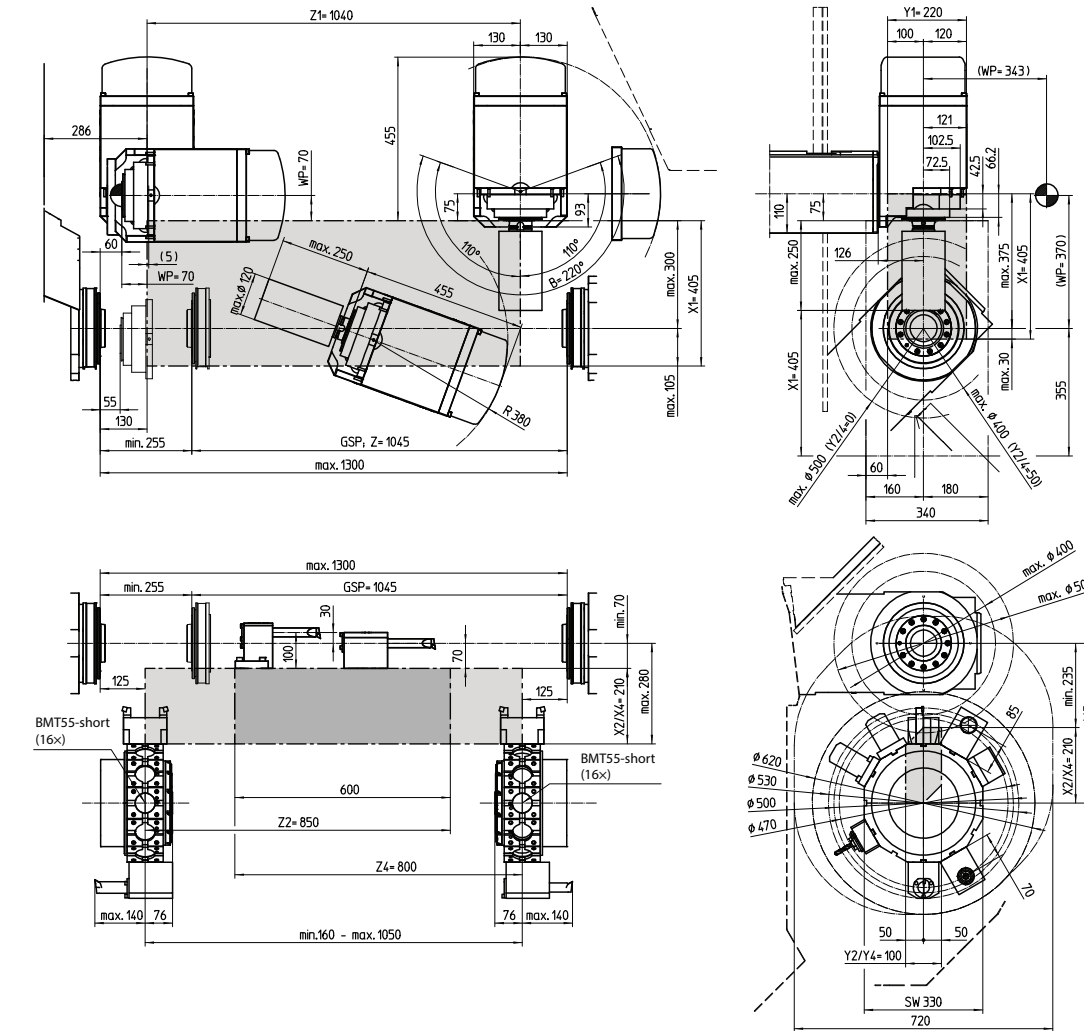

Indications in millimetres

WORK AREA

Working area HT 65 PM HP with 16-position BMT45P turret

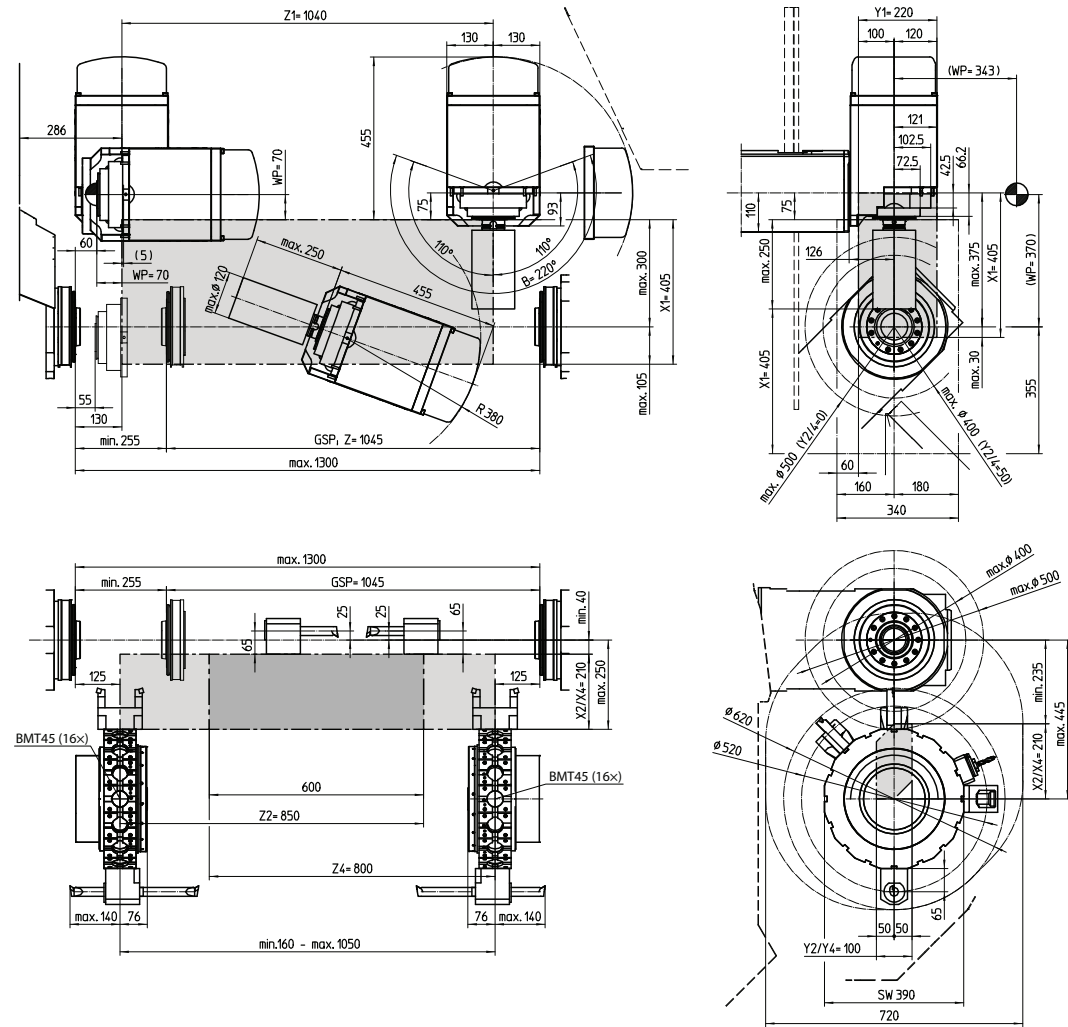

Indications in millimetres

POWER AND TORQUE

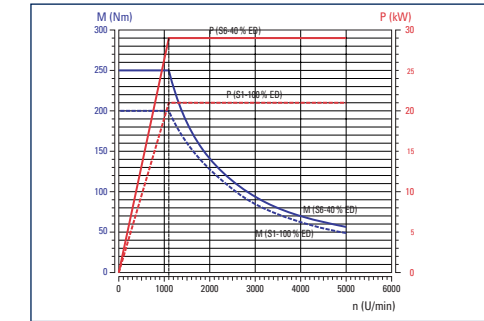

Main and counter spindle Ø 65 mm / Ø 76 mm

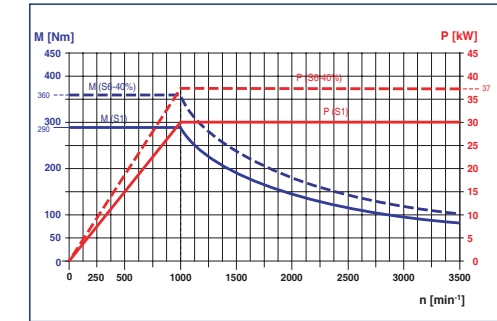

Main spindle Ø 95 mm

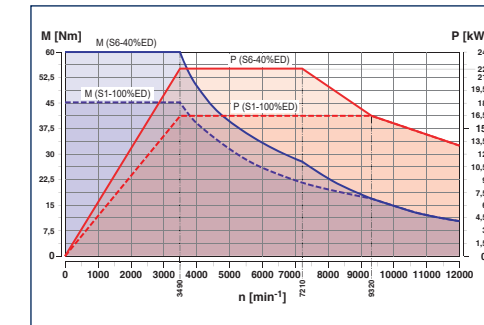

Milling spindle with max. 12000 rpm

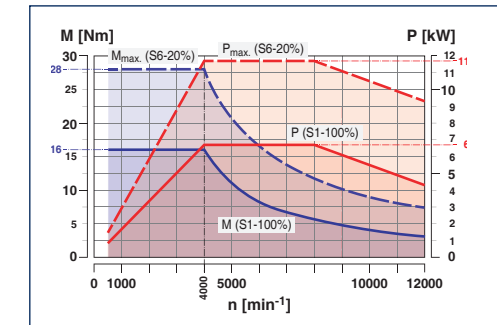

Tool turret with direct drive - BMT55P

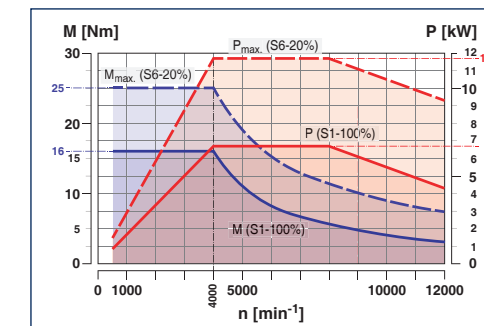

Tool turret with direct drive - BMT45P

TECHNICAL DATA

Work area

Swing over bed	500 mm
Distance between spindle noses	1300 mm
Maximum turning diameter	500 mm
Max. part length	1040 mm
Max. bar-stock diameter	65 (76,2/95) mm

Travel

Travel X1 / X2 / X4	405 / 210 / 210 mm
Travel Z1 / Z2 / Z4	1040 / 850 / 800 mm
Travel Y1 / Y2 / Y4	220 / 100 / 100 mm
Traverse path counter spindle Z3	1045 mm

Main spindle

Speed range (infinitely variable)	0 – 5000 (4000/3500) rpm
Maximum torque	250 (360) Nm
Spindle nose DIN 55026	A2-6 (A2-8)
Spindle bearing (inside diameter)	105 (130/140) mm
Spindle bore (excluding draw-back rod)	∅ 73 (86/106) mm

Counter spindle

Speed range (infinitely variable)	0 – 5000 (4000/3500) rpm
Maximum torque	250 (250) Nm
Spindle nose DIN 55026	A2-6 (A2-8)
Spindle bearing (inside diameter)	∅ 105 (130/140) mm

C-axis

Resolution	0,001°
Rapid traverse	1000 rpm

Drive power

Main spindle (AC integrated-spindle motor)	29 (37) kW
Counter spindle (AC integrated-spindle motor)	29 kW

Milling spindle – Powermill

Speed range	0 – 12000 rpm
Maximum torque	60 Nm
Maximum drive power	22 kW
Type of tool shank	HSK-T63

B-axis

Travel range	220°
Holding torque of clamp	4000 Nm
Interpolating drive torque	332 Nm

Tool magazine

Tool storage capacity	40 / 80 mm
Max. tool diameter	∅ 80 (∅ 120) mm
Max. tool length	250 mm
Max. tool weight	5 kg

Tool turret with BMT interface and direct drive

Number of tool positions	2x 12 (2x16)
Precision interface	BMT55P (BMT45P)
Tool cross-section for square-shank tools	25 x 25 (20 x 20) mm
Shank diameter for boring bars	40 (32) mm
Tool indexing time	0,5 sec.
Speed range of driven tools	0 – 12000 rpm
Torque of driven tools	28 (25) Nm
Drive power of driven tools	11,7 (11,7) kW

Feed drives

Rapid speed X1 / X2	30 m/min
Rapid speed Z1 / Z2 / Z3	30 m/min
Rapid speed Y1 / Y2	12 m/min
Feed force X1 / X2	5000 N
Feed force Z1 / Z2	8000 N
Feed force Y1 / Y2	7000 N

Coolant system

Tank capacity	400 + 980 l
Coolant pumps for the tool systems	1x 40 bar + 2x 25 bar
Scavenge pumps for the work area	2 x 3,7 bar

Power consumption

Connected load	68 kVA
Compressed air	6 bar

Dimensions/weight

Height of center above floor	1313 mm
Overall height	2375 mm
Required space L x D (included chip conveyor)	5253 x 3200 mm
Total weight	13500 kg

Safety devices CE compliant

beyond standard /

EMCO GmbH / Salzburger Str. 80 / 5400 Hallein-Taxach / Austria / T +43 6245 891-0 / F +43 6245 86965 / info.at@emco-world.com

www.emco-world.com