

EMCO

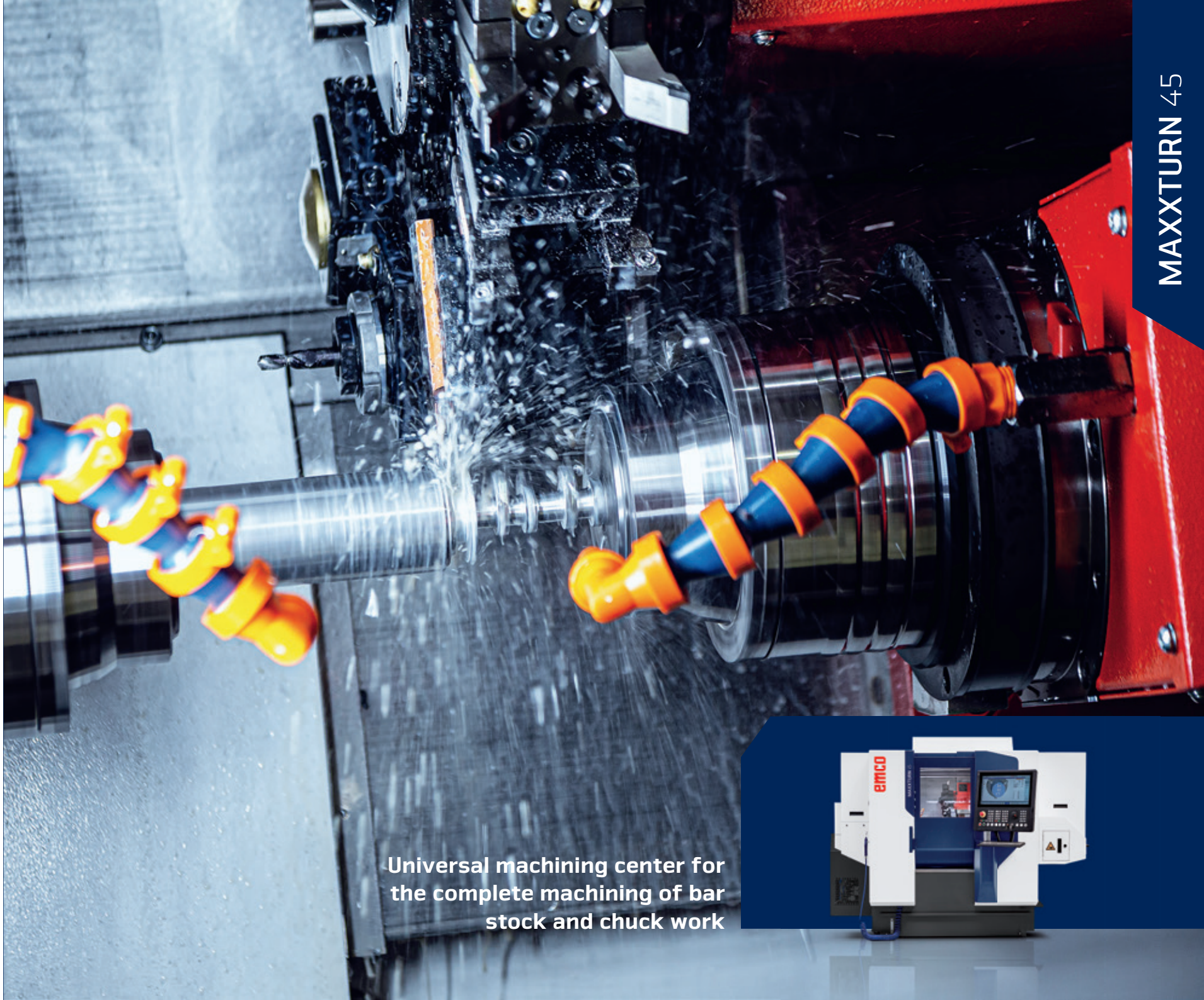

Universal machining center for
the complete machining of bar
stock and chuck work



MAXXTURN 45

COMPLETE SOLUTIONS – VERSATILE POSSIBILITIES

The perfect solution for economic, off-the-shelf complete machining. Fitted with two water-cooled spindle motors, HSC-Revolver, a high-precision C-axis and extremely fast rapid motion speeds, the MAXXTURN 45 gives you everything you need for manufacturing complex turned-milled parts efficiently and at a low price. The highlight of the machine is its very stiff Y-axis with long travel – for almost unlimited machining capabilities with maximum precision. The MAXXTURN 45 comes with a choice of Siemens or Fanuc control and with Shopturn or ManualGuide i as standard equipment.



Camshaft
(Brass)

1 HSC TOOL TURRET

- / 12-station tool turret
- / VDI25 quick-change system
- / 12 driven tool positions
- / Max. speed range: 0 – 8000 rpm

2 WORKSPACE

- / Plenty of open space
- / Optimal chip flow
- / Easily accessible

3 HYDRAULIC UNIT

- / Ergonomically placed
- / Automatic pressure control switching and adjustment
- / Optimal overview

4 MACHINE DESIGN

- / Minimal floor space

5 Y AXIS

- / Travel +40 / –30 mm
- / 90° implemented in the machine construction
- / Large distance between guide rails
- / Stable and compact construction, without restrictions

6 MACHINE COVER

- / All-round protection against chips
- / 100% coolant retention
- / Large safety glass window in door
- / Clear view of the workspace
- / Built-in buttons for operator convenience



Machine with optional equipment

7 CONTROL SYSTEM

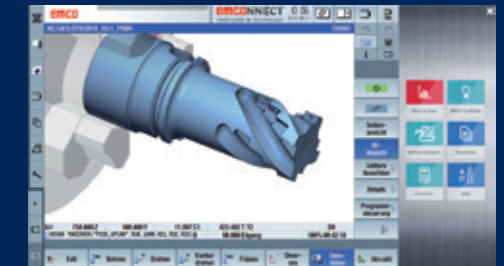

SINUMERIK 840D SL WITH OPERATE 4.8.

- / Dialog programming SHOPTURN/SHOPMILL
- / 3D simulation for process verification
- / 22" MULTI-TOUCH monitor
- / Pivotable and adjustable in height
- / EMCONNECT process assistant as basis for SMART FACTORY



FANUC 31i WITH IHMI

- / Dialog programming MANUAL GUIDE i
- / 3D simulation for process verification
- / 22" MULTI-TOUCH monitor
- / Pivotable and adjustable in height
- / EMCONNECT process assistant as basis for SMART FACTORY

CONSTRUCTION

1 MAIN SPINDLE

- / Integrated spindle motor (ISM)
- / Large speed range 0-7000 rpm
- / High dynamics
- / A2-5 spindle connection
- / Bar capacity diameter \varnothing 45 (S1) mm
- / Programmable clamping stroke control

2 MACHINE BED

- / Extremely stiff welded steel fabrication
- / Compact structure
- / Very high thermostability
- / Filled with vibration-absorbing material

3 ROLLER GUIDES

- / In all linear axes
- / Preloaded
- / No backlash in any direction of force
- / High rapid motion speeds
- / No wear
- / Minimal lubrication

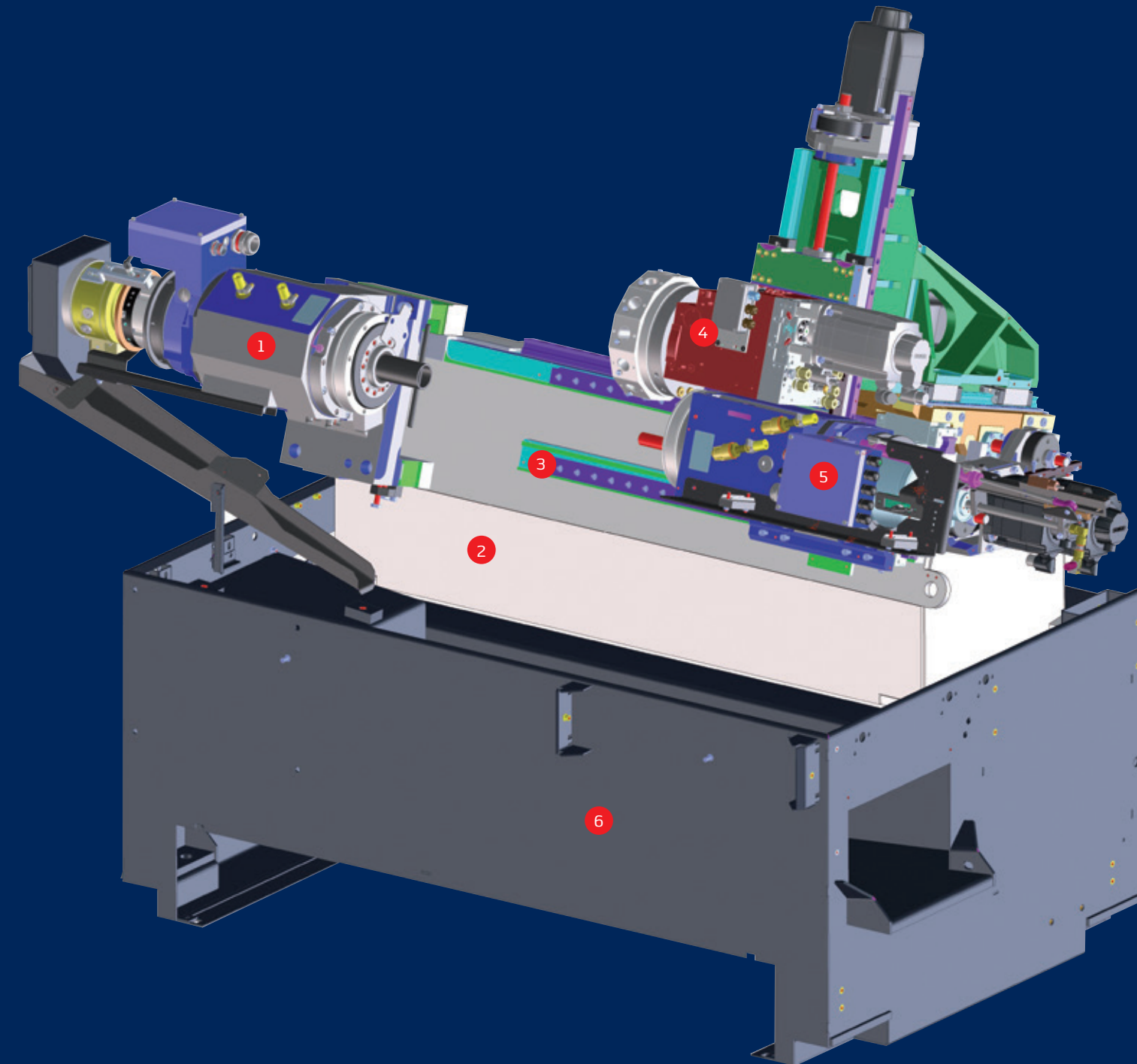

4 TOOL TURRET

- / VDI quick change system
- / 12 driven tool stations
- / No alignment of the tool holder
- / Can be used on both spindles
- / Swivel speed adjustable with override

5 COUNTER SPINDLE

- / Integrated spindle motor (ISM)
- / Large speed range: 0-7000 rpm
- / High dynamics
- / A2-5 spindle connection
- / Clamping cylinder without through-hole, equipped with a parts ejector
- / Programmable clamping stroke control

6 MACHINE STAND

- / Thermally isolated from the machine base
- / Coolant container that is larger and easier to clean
- / No levelling required
- / 100% sealed against coolant leaks

Power

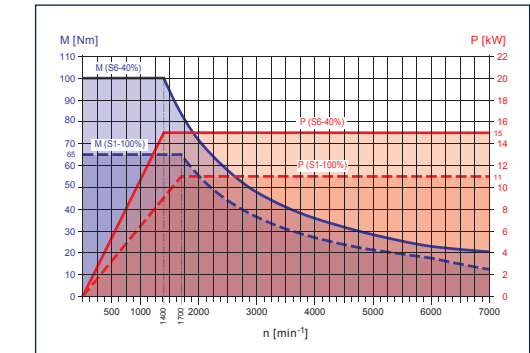

Main spindle / counter spindle motor characteristics

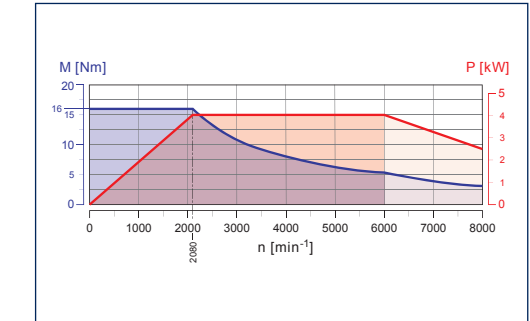

Characteristic of driven tools
MT45-HSC tool turret

TECHNICAL HIGHLIGHTS

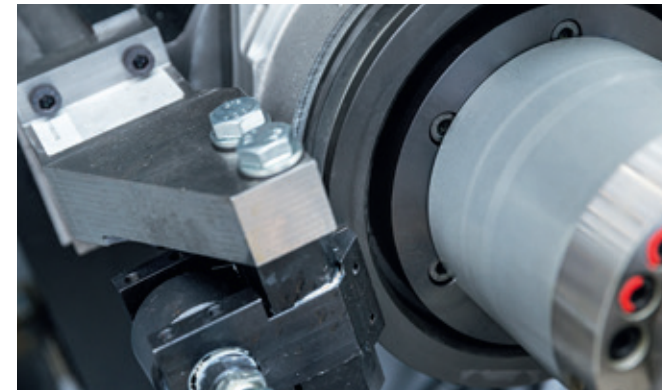
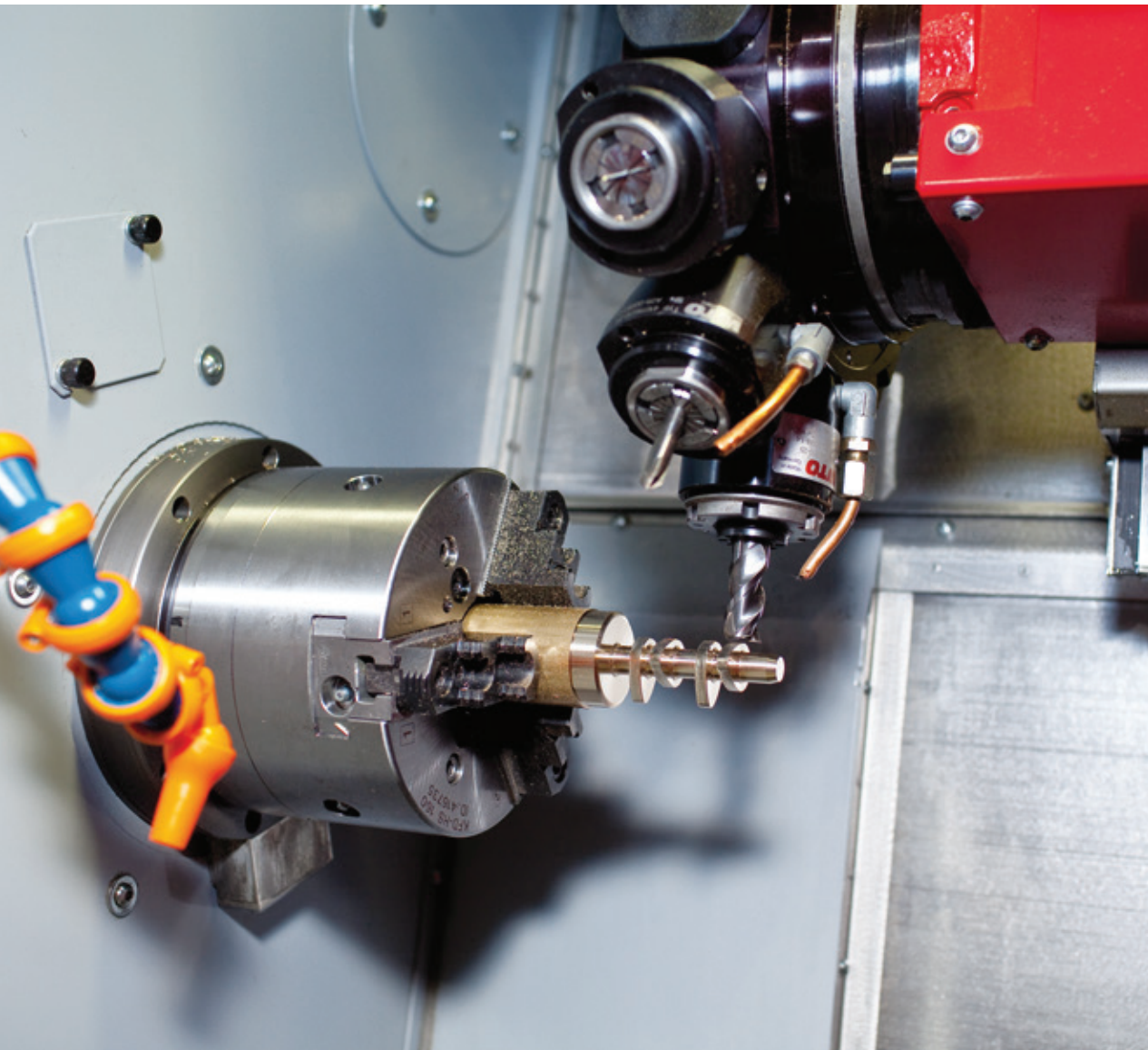

DISC BRAKE AT MAIN AND COUNTER SPINDLE

Milling and drilling operations are generally done with a positioned or interpolating C-axis. But additionally both spindles can be clamped at any position if needed.

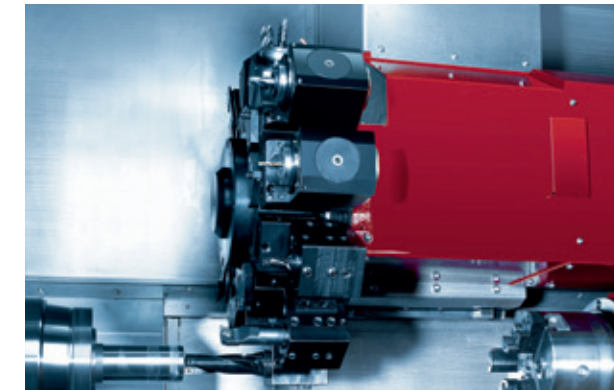

TOOL HEAD

12-position VDI 25 radial turret with single-motor engineering. A servo motor powers the driven tools and the swivel movement. No tool rise. Switches with bidirectional logic. Every station can hold driven tool holders with a DIN 5480 coupling.



COUNTER SPINDLE AND PARTS CATCHER

The counter spindle includes a parts ejector with stroke monitoring and coolant feed. It ejects the parts automatically into the parts catcher, which then removes them from the machine and stores them in a bin or on an accumulating conveyor.

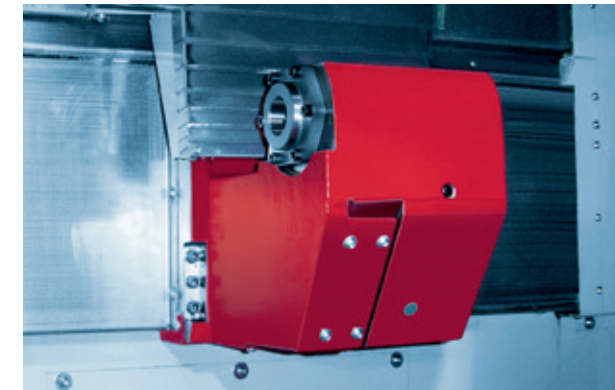

TAILSTOCK

On the MAXXTURN 45 with tailstock, the tailstock is set up on the linear roller slide and can be automatically positioned within a range of 510 mm. The live center is integrated into the body of the tailstock and can be removed using a pressure wedge.

HIGHLIGHTS

- / Very high thermostability
- / Extreme machining precision
- / High rapid motion speeds
- / Very stable Y-axis with long travel
- / High-precision C-axis
- / Driven tools
- / Very compact machine layout
- / Cutting-edge control technology from Siemens or Fanuc
- / Simple, dialog-supported programming
- / Made in the Heart of Europe



MAIN SPINDLE

The main spindle with large precision bearings allows a very wide range of speeds, combined with extremely good true running characteristics. Cooling fins are fitted to the symmetrical headstock to ensure optimum thermal stability.

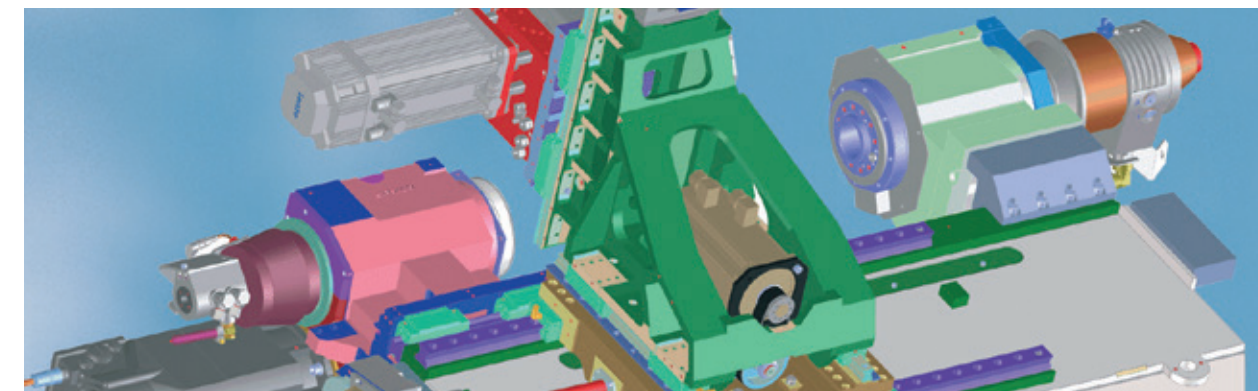

Y-AXIS

The Y-axis is integrated into the basic machine structure and stands at 90° to the X axis. Extremely short projections form the basis for solid turning and drilling operations, as well as milling operations without interference contours.

NETWORKS ARE CREATED INDIVIDUALLY – OUR SOLUTIONS AS WELL



Staying in touch is important not only among human beings. Persons, machines and the whole production environment must also be connected perfectly and safely in order to ensure efficient procedures during the production process. With EMCONNECT, the machine is optimally equipped for this purpose. The optional EMCONNECT Digital Services offer innovative online services for optimized machine operation. The user has always the control of the machine status. The automatic notification in case of malfunctions or standstill of the machine as well as the extended capabilities for remote maintenance, minimise downtimes.



Integration into control

EMCONNECT offers several possibilities of operation according to different situations. For quick access, apps may be used simultaneously in the side panel of controlling.

In this way, you can always look at your familiar numerical control, the well-known centrepiece of the machine.

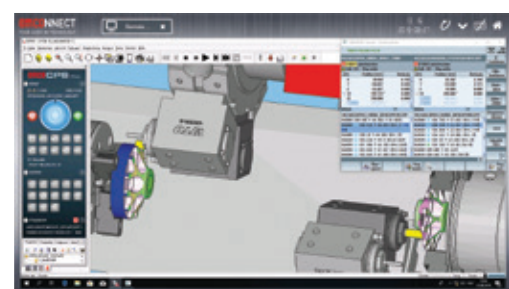

An innovative concept

These powerful apps may be used independently from the control, while in the background the machine is busy in the production process. With only one click, you can change at any moment between numerical control and EMCONNECT. This is possible with the help of an innovative and ergonomic control panel, equipped with a modern 22" multi-touch display, an industrial PC with associated keyboard and HMI hotkeys.



The control panel as central platform

With EMCONNECT, the control panel of the machine becomes the central platform for the access to all the operative functions. The user gets every type of support from the apps, which directly provide all the necessary applications, data and documents. In this way, EMCONNECT makes an important contribution to a highly efficient processing at the machine.



Comprehensive connectivity options

With the remote support, the web browser and the remote desktop, there are numerous connectivity options, even beyond the direct production environment. With the help of the integrated remote support, it is easily possible to carry out the remote diagnosis and remote maintenance. The optionally available OPC UA interface enables data exchange with the IT system environment and interaction with other machines for automation at shop floor level.

EMCONNECT HIGHLIGHTS AND FUNCTIONS

- / Fully connected**
Connection to all applications via remote control of the office computer and the web browser
- / Structured**
Clear monitoring of the machine state and the production data
- / Customized**
Open platform for modular integration of customer-specific applications
- / Compatible**
Interface for seamless integration into the operating environment
- / User-friendly**
Intuitive and production-optimized touch operation data
- / Future-proof**
Continuous extensions as well as easy updates and upgrades

Standard Apps

Control	Dashboard
Machine Data	System
Remote Desktop	Web Browser
Remote Support	Settings
Cutting Calculator	Calculator
Notes	Service
Documents	EMCO TechSheet
GD&T	File Import
Shopfloor Data	Thread Reference
	Tricalc

Optional

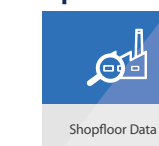

Shopfloor Data



/ Ing. Johann Brisker
Brisker GmbH

"All EMCO turning machines are automated with short bar or bar loaders, which frees up employees for other tasks and, as a consequence, increases productivity."

The EMCO short bar loaders. Universal and powerful.



SHORT AND TO THE POINT.

The EMCO SL1200 is the perfect solution for automatic feeding and loading of cut-to-length bars. The key advantages are a small footprint and rapid loading times resulting from shorter strokes.

The technology. The SL1200 can be used immediately as a "plug-and-play" solution. Their extremely small footprint enables processes to be automated even if space is tight. Apart from complying with the latest safety requirements, it is easy to operate and moveable

for service purposes. Besides, it can comfortably be incorporated into the production process using the machine control's programme input masks. Minimum setup efforts are required when switching over to other bar diameters.



EMCO SL1200

Space-saving and cost-effective bar loading magazine. Operation and programming could not be easier. May also be used for loading single items through the lathe's main spindle.

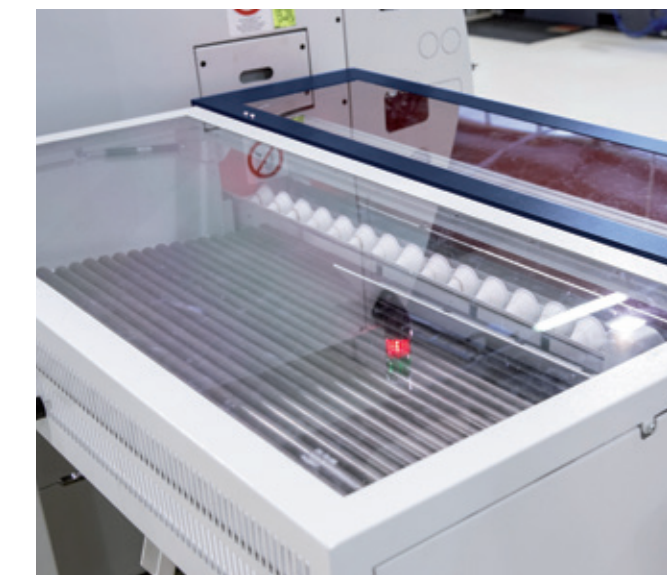

MATERIAL STORAGE

The material storage surface with a length of 560 mm is arranged at the rear of the bar loader in a manner with no influence whatsoever on the space available. Depending on the diameter it is possible to store a different number of short bars.

THE BENEFITS

- / Small footprint
- / Easy to use
- / Short feed times
- / Fast, straightforward changeover
- / Option to load individual workpieces
- / Central diameter adjustment
- / The loader operates without oil
- / Ergonomic EMCO design

Technical data	SL1200
Bar diameter	Ø 8 – 95 mm
Max. bar length	1200 mm
Min. bar length	150 mm
Max. bar weight	45 kg
Material storage length	approx. 560 mm
Feed rate	0 – 60 m/min
Bar change time	approx. 15 sec.
Dimensions (L x W)	1700 x 1250 mm
Weight	approx. 500 kg

THE EMCO SWING LOADER. THE INTEGRATED SOLUTION.

Tailor-made solutions. For preformed blanks and parts with a diameter larger than the spindle capacity, we offer an integrated swing loader for fully automatic loading and part removal. This has been designed to form a harmonious single entity with the machine. The machine control system takes care of positioning. A short bar loader and a 3-meter bar loader are available from EMCO for workpieces from bar stock.



ADVANTAGES

- / Fully automated loading and unloading of the workpieces
- / Short loading and unloading time
- / Flexible for shaft or flange parts
- / Oriented loading into the clamping device
- / Simple programming via the Sinumerik control
- / CNC-controlled movements

MAXIMUM OUTPUT – MINIMUM SPACE REQUIRED.

The EMCO swing loader is a universal loading system for all types of preformed blanks. It can be customized individually to the customer's requirements using numerous gripper and handling systems. How we do it: we standardize the components but create a customized solution. The result: a custom-tailored machine for the same price as a standard unit.

Blank feeding systems, gripper and handling systems

Feed systems specific to particular blanks allow preformed workpieces to be loaded in the working spindle correctly oriented, which enables economical unmanned operation.

A wide range of gripper and handling systems.



Large storage capacity chain feeding system for loading preformed blanks with the correct orientation.

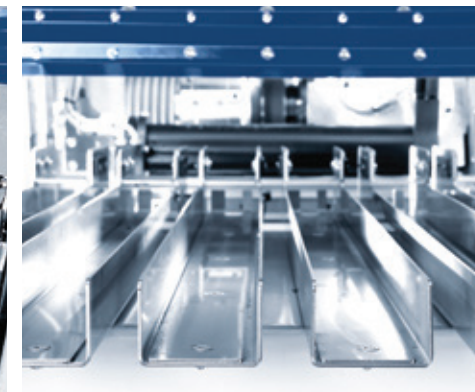

Multiple infeed chutes for loading rotationally-symmetrical blanks. The length of the blanks determines the number of infeed chutes.



Chain feeding system with V-supports for preformed shaft parts of various shapes.

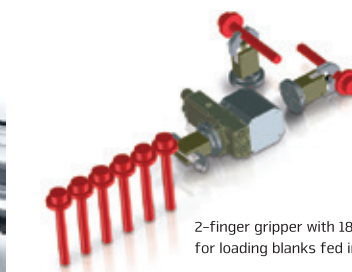

2-finger gripper with 180° rotary module for loading blanks fed in vertically

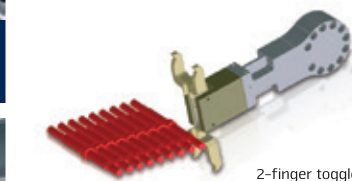

2-finger toggle lever gripper for loading shaft parts



Multiple infeed chutes for loading rotationally symmetrical blanks. A sensor monitors the availability of blank parts for each infeed chute.

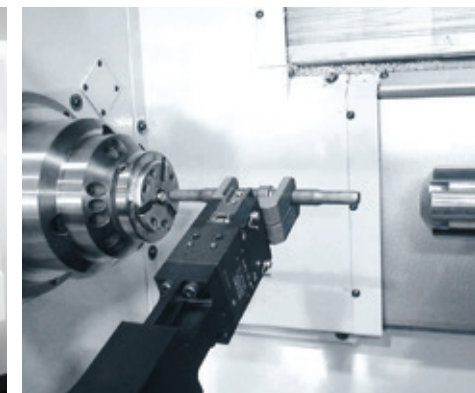

Shaft gripper for automatically loading pre-formed shafts.

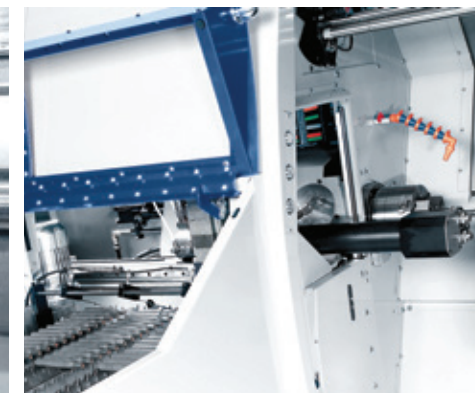

Fully automatic shaft loading. Feed-in via a conveyor belt, removal via the finished parts pick-up device.

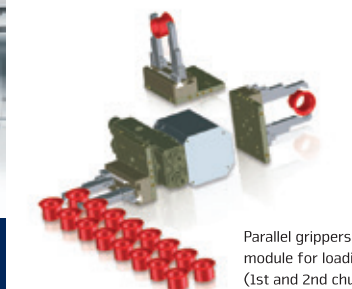

Parallel grippers with 180° rotary module for loading shaft parts (1st and 2nd chucking)

MACHINE LAYOUT

Machine layout MT45 with EMCO SL1200

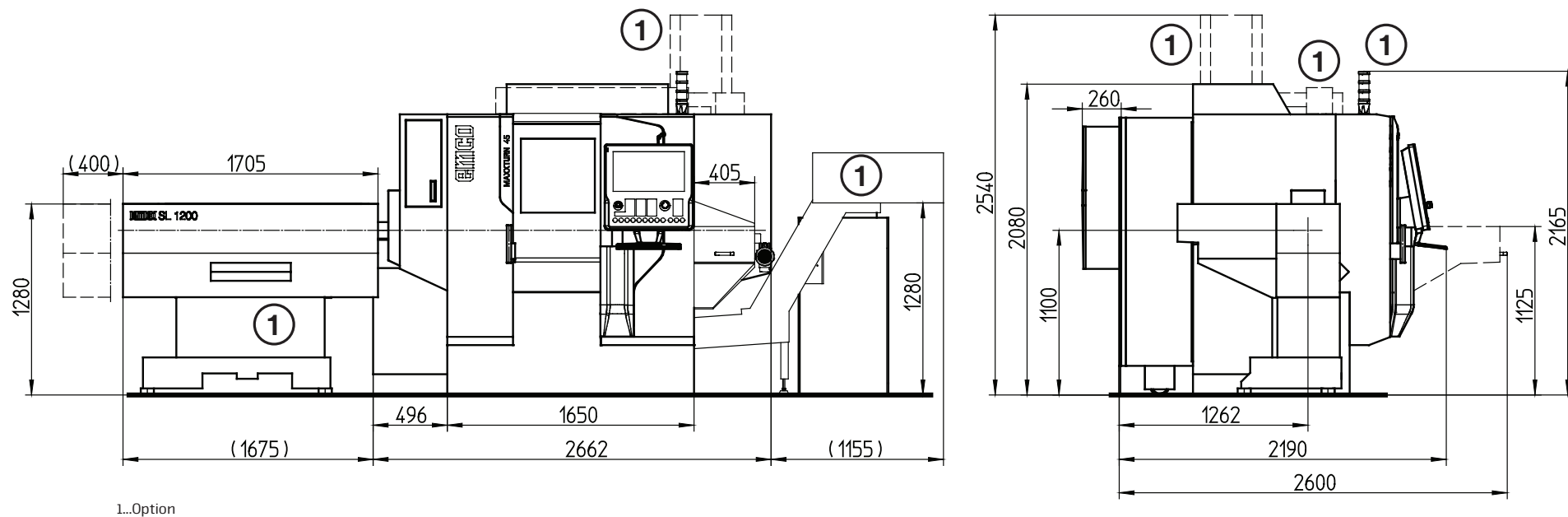

Indications in millimetres

FLOOR PLAN

Floor plan MT45

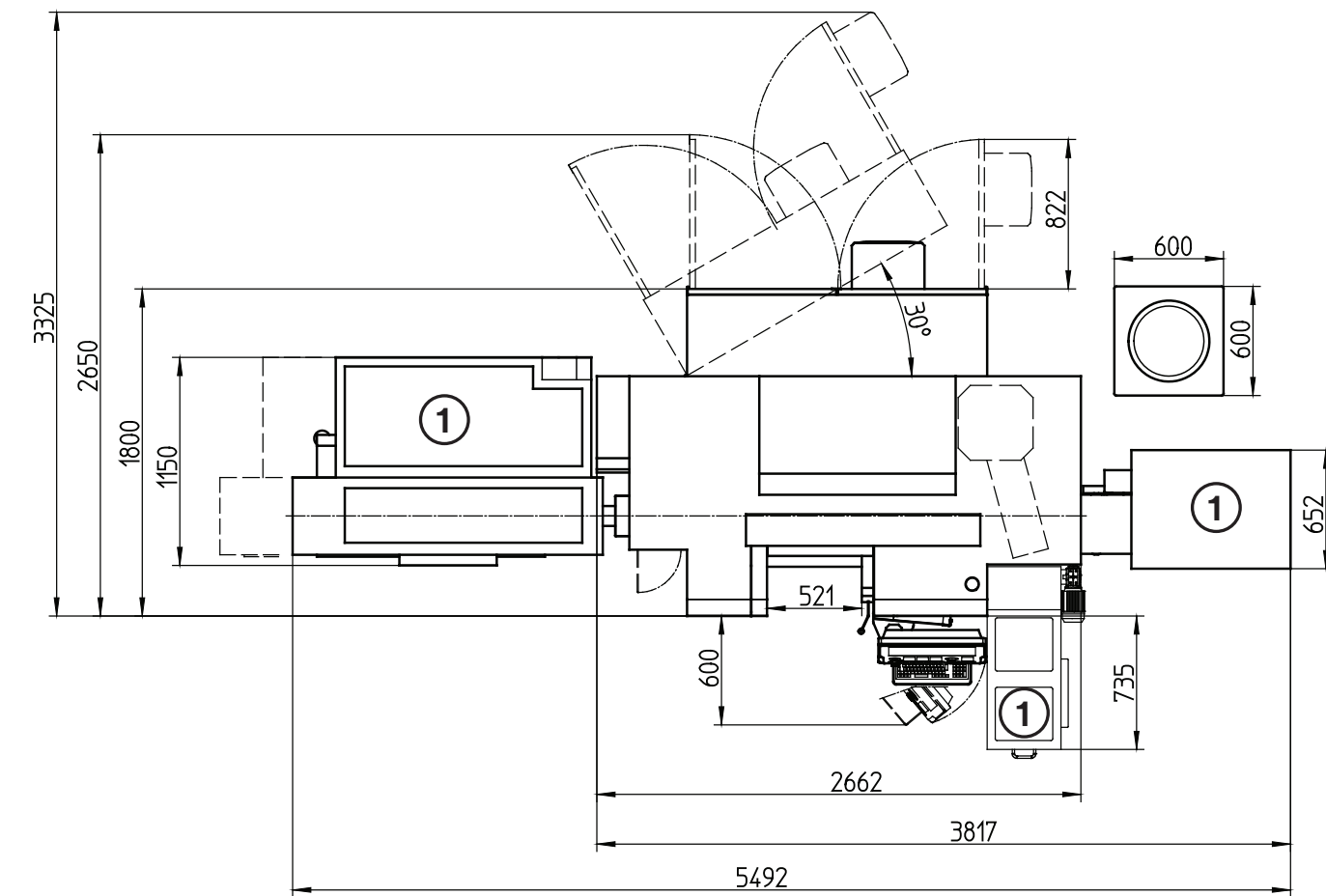

Indications in millimetres

WORK AREA

MT45 with HSC-TOOL TURRET

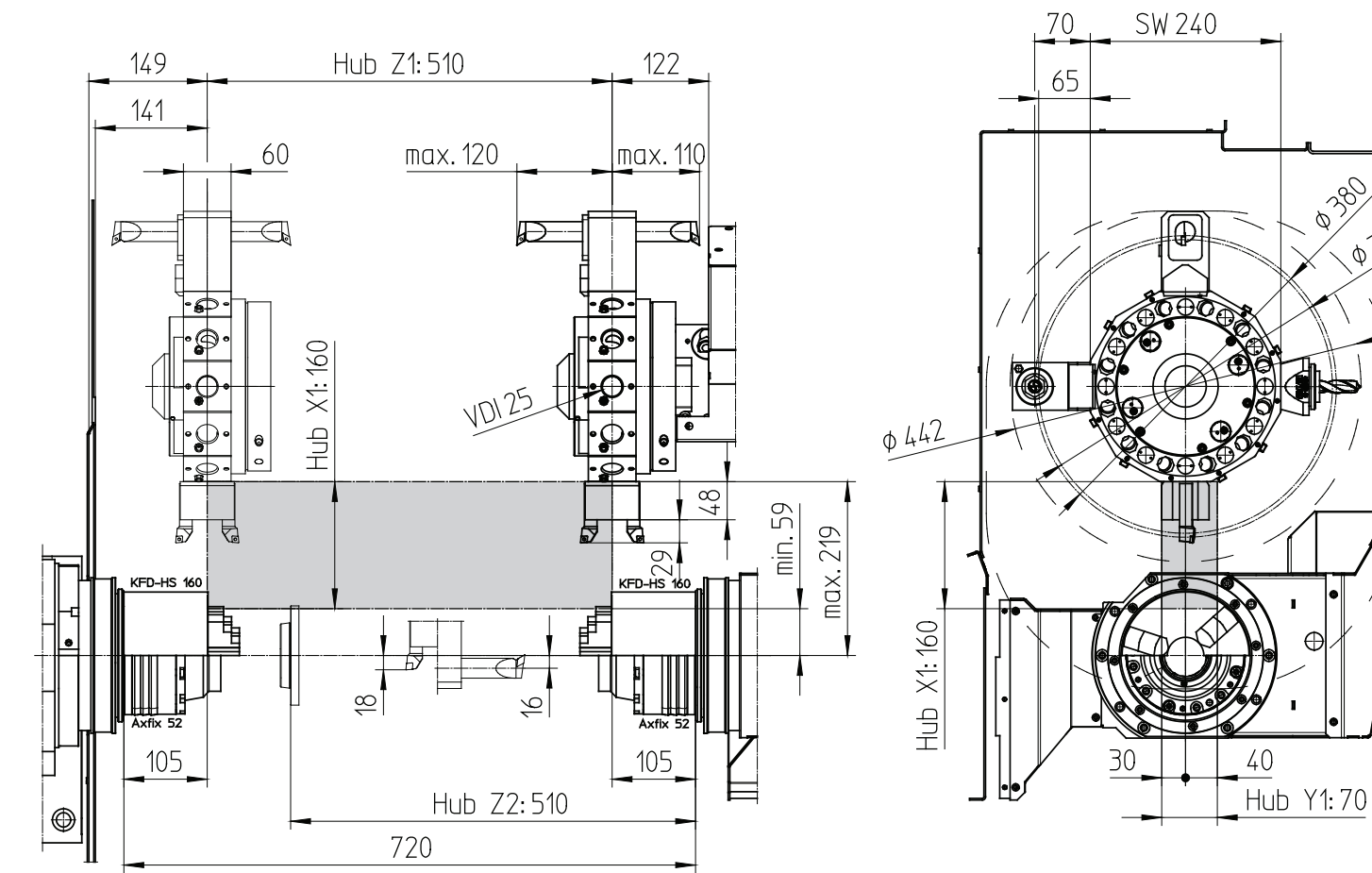

Indications in millimetres

TECHNICAL DATA

Work area

Swing over bed	Ø 430 mm
Swing over cross slide	Ø 300 mm
Main spindle / counter spindle distance	720 mm
Max. turning diameter	Ø 300 mm
Maximum part length	480 mm
Maximum bar diameter	Ø 45 (51) mm

Travel

Travel in X / Z	160 / 510 mm
Travel in Y	+40 / -30 mm

Main spindle (ISM)

Speed range	0 – 7000 rpm
Maximum torque at spindle	100 Nm
Spindle nose DIN 55026	A2-5
Spindle bearing (inner diameter at front)	Ø 85 mm
Spindle bore hole	Ø 53 mm

Counter spindle (ISM)

Speed range	0 – 7000 rpm
Maximum torque at spindle	100 Nm
Spindle nose DIN 55026	A2-5
Spindle bearing (inner diameter at front)	Ø 85 mm
Spindle bore hole	Ø 53 mm

C axis

Resolution	0,001°
Rapid motion speed	1000 rpm
Spindle indexing (disc brake)	0,01°

Drive power

Main spindle	15 kW
Counter spindle	15 kW

Tailstock

Tailstock travel	510 mm
Maximum thrust	6000 N
Maximum travel speed	approx. 20 m/min
Tailstock bore taper	MT4

Tool turret

Number of tool positions	12
VDI shaft (DIN 69880)	VDI 25
Tool cross-section for square tools	16 x 16 mm
Shaft diameter for boring bars	25 mm
Turret indexing time	0,2 sec.

Driven tools

Speed range	0 – 8000 rpm
Maximum torque	16 Nm
Maximum drive power	4 kW
Number of driven tools	12

Feed drives

Rapid motion speed X / Y / Z	24 / 10 / 30 m/min
Feed force in the X / Y axes	4000 / 4000 N
Feed force in the Z axis	6000 N
Acceleration time from 0 to rapid X / Z	0,1 sec.
Positioning scatter Ps VDI 3441 in X / Y / Z	3 / 3 / 3 µm

Coolant system

Tank volume	250 liters
Pump power standard	0,57 (2,2) kW
Pump capacity at 3,5 bar / 1 bar	15 / 65 l/min
Pump capacity at 10 bar / 5 bar (optional)	5 / 50 l/min

Power consumption

Connected load	39 kVA
Compressed air	6 bar

Dimensions

Height of spindle center above floor	1100 mm
Total machine height	2080 mm
Foot print (without chip conveyor) L x D	2665 x 2200 mm
Total weight	4000 kg

Safety devices CE conform

beyond standard /

EMCO GmbH / Salzburger Str. 80 / 5400 Hallein-Taxach / Austria / T +43 6245891-0 / F +43 624586965 / info@emco.at

www.emco-world.com