

EMCO

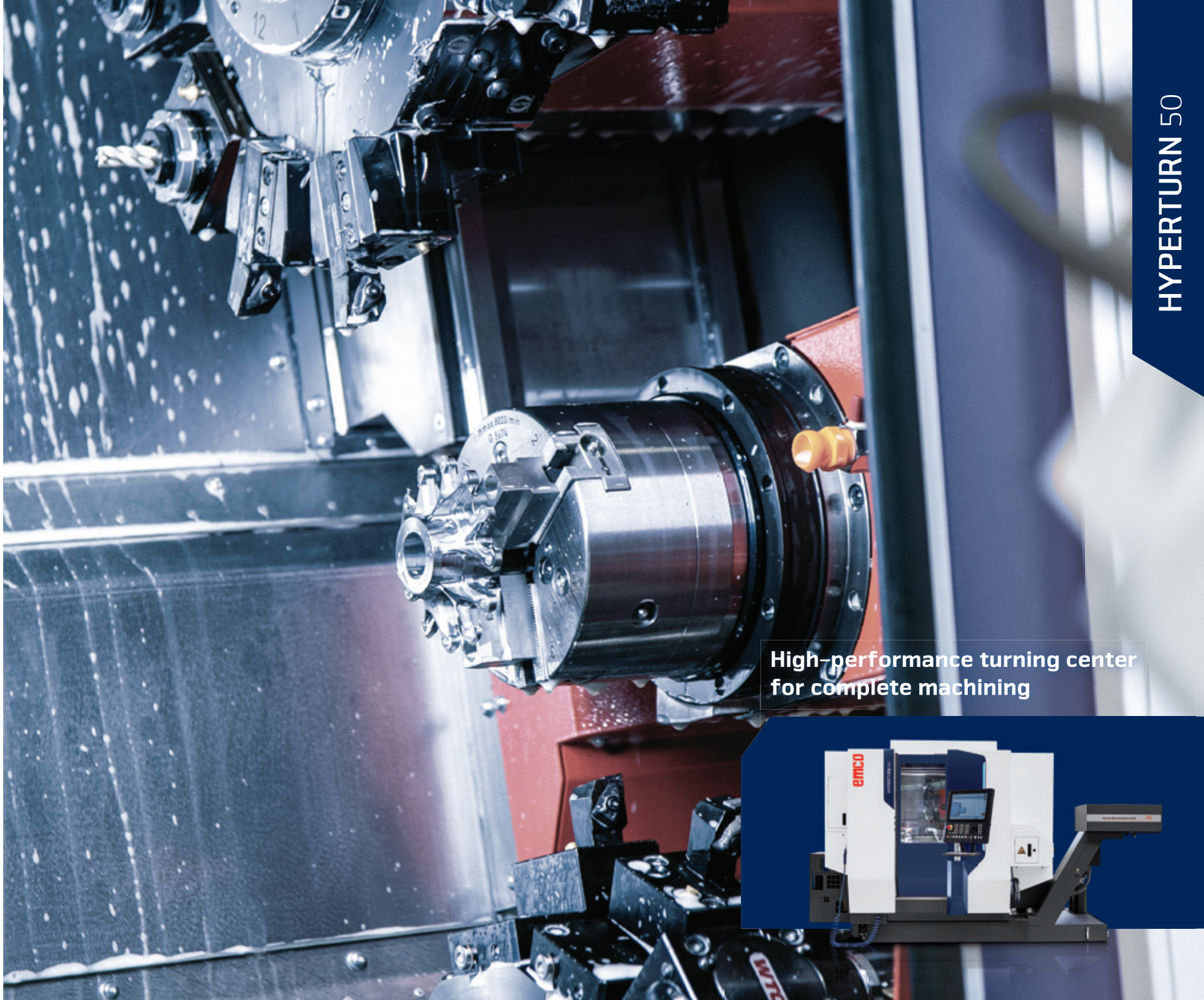

High-performance turning center
for complete machining



HYPERTURN 50

HIGHLY PRO- DUCTIVE AND YET EXTREMELY FLEXIBLE

Now in its third generation, the new HYPERTURN 50 stands out by merging a significantly larger work area with compact design. This enables the integration of a 12- or 16-station turret with direct drive and BMT interface. The basic machine still features a VDI25 servo turret with quick-change interface, which is why many customers may continue to use their existing tool holders. Although the machine now offers a speed range of 0-8000 rpm, the tried and tested two-piece base structure remains unchanged. This makes it possible to achieve high precision and thermostability despite increased dynamics. The machine is primarily used in the field of general machine and equipment engineering, but also in high-precision areas such as medical technology and the jewellery industry.

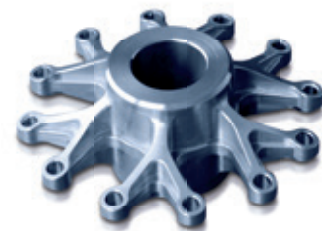

Chain wheel adapter
(Steel / 42 Cr Mo 4)

- 1 MAIN SPINDLE**
- / Integrated, water-cooled spindle motor (ISM)
 - / High drive power: 15 (18) kW
 - / High torque: 100 (150) Nm
 - / Wide speed range: 0 – 7000 (5000) rpm
 - / Extremely dynamic
 - / Bar capacity \varnothing 51 (65) mm

- 2 COUNTER SPINDLE**
- / Integrated, water-cooled spindle motor (ISM)
 - / High drive power: 15 kW
 - / High torque: 100 Nm
 - / Wide speed range: 0 – 7000 rpm
 - / Highly dynamic
 - / Bar capacity \varnothing 45 mm (optional)

- 3 UPPER TOOL TURRET**
- / 12-station VDI25 tool turret with milling drive (0 – 8000 rpm)
 - / 12-station / 16-station BMT45P tool turret with direct drive (0 – 12000 rpm)
 - / Servo-controlled
 - / Up to 50 bar coolant pressure as a standard

- 4 Y-AXIS**
- / +/- 40 mm stroke
 - / 90° implemented in the machine construction
 - / Large distance between guides
 - / Stable and compact construction

- 5 LOWER TOOL TURRET**
- / 12-station VDI25 tool turret with milling drive (0 – 8000 rpm)
 - / 12-station / 16-station BMT45P tool turret with direct drive (0 – 12000 rpm)
 - / Servo-controlled
 - / Up to 50 bar coolant pressure as a standard

- 6 CONTROL UNIT**
- / Ergonomically designed
 - / +/- 100 mm height adjustment
 - / Swiveling 50°
 - / Sinumerik ONE with EMCONNECT and 22" multi-touch screen
 - / Fanuc 31i-B Plus with 22" multi-touch screen



Machine with optional equipment



LED STATUS LAMP. With the multicolor status indicator the operator gets the individual machine conditions visualized.

- 7 CHIP CONVEYOR**
- / Hinge type chip conveyor
 - / 1100 mm ejection height
 - / Integrated 300 litre coolant tank
 - / Turret pumps: 2 x 14 bar
 - / Flushing pumps: 2 x 3.7 bar

- 8 COMPACT MACHINE DESIGN**
- / Minimal floor space

STRUCTURE

1 ROLLER GUIDES

- / In all linear axes
- / Preloaded and backlash-free
- / High rapid motion speeds
- / No wear
- / Minimal lubrication required

2 MAIN SPINDLE

- / Wide speed range
- / C-axis for milling operations
- / KK5 (KK6) spindle nose
- / Hollow clamping system $\varnothing 51$ (65) mm
- / Programmable clamping stroke monitor

3 MACHINE BASE

- / Extremely torsion-resistant welded-steel construction
- / Compact design
- / Maximum thermostability
- / Filled with vibration-absorbing material

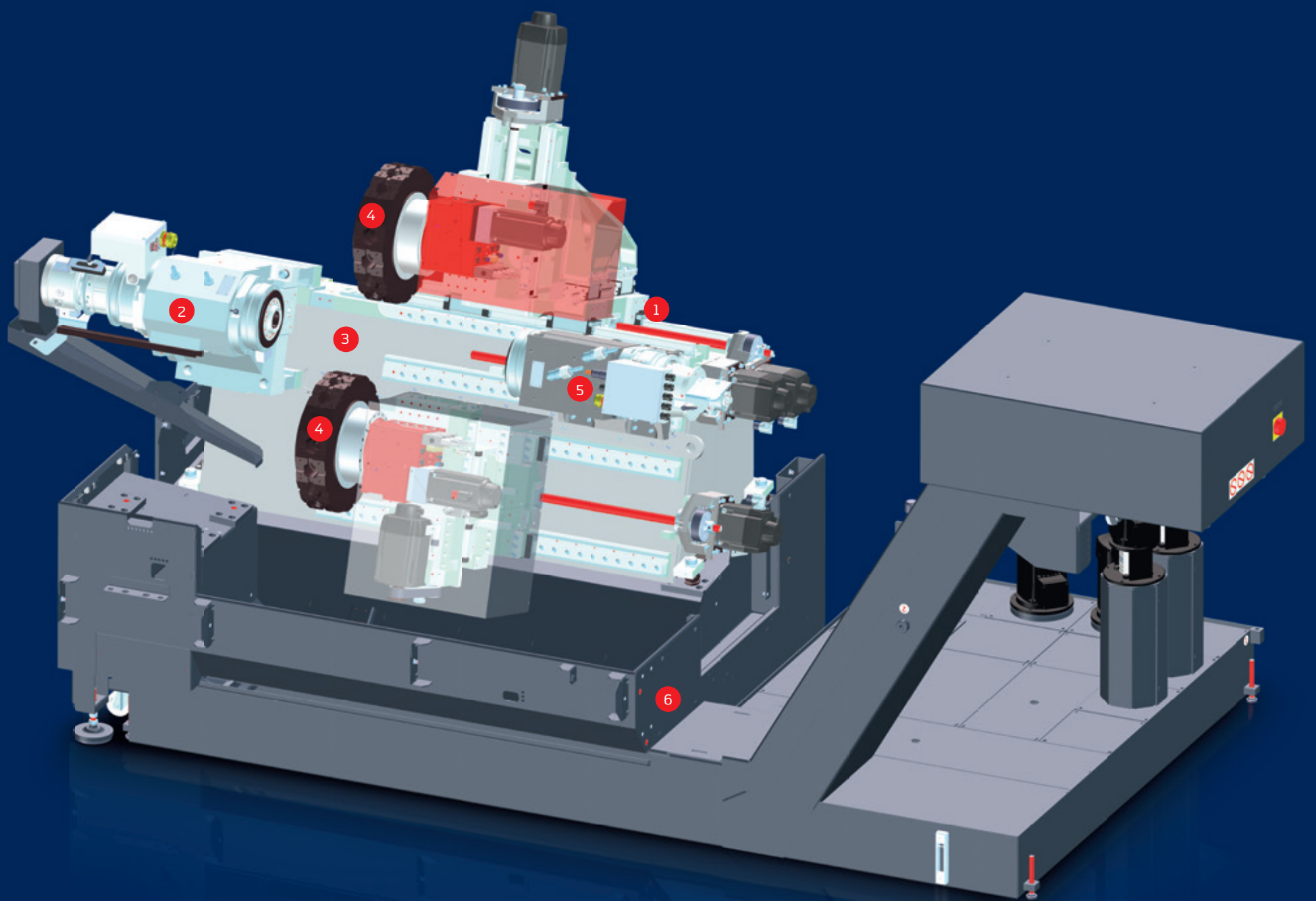

4 TOOL TURRET

- / 2 x 12-station VDI25 turrets
- / 2 x 12-station / 16-station turrets BMT45P
- / No alignment of the tool holder
- / Can be used flexibly on both spindles
- / Swivel speed adjustable with override

5 COUNTER SPINDLE

- / Wide speed range
- / C-axis for milling operations
- / Spindle clamp
- / KK5 spindle nose
- / Full clamping system with parts ejector
- / Programmable clamping stroke monitor

6 MACHINE STAND

- / Solid welded-steel design
- / Thermally separate from the machine base
- / Filled with vibration-absorbing material
- / 100% sealed against coolant leaks

Performance and Torque

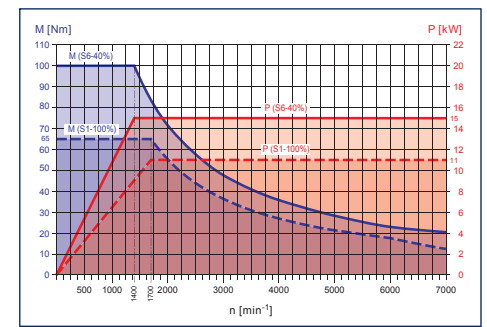

HYPERTURN 50 main spindle / counter spindle

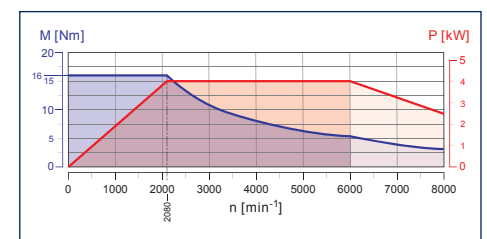

VDI25 tool turret with driven tools

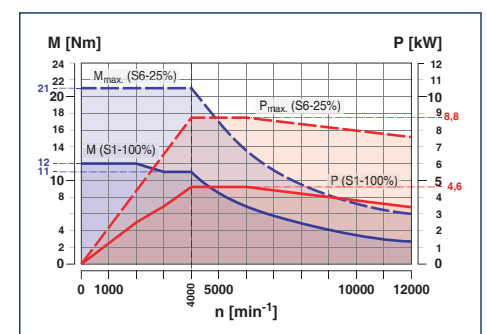

BMT45P tool turret with direct drive

TECHNICAL HIGHLIGHTS

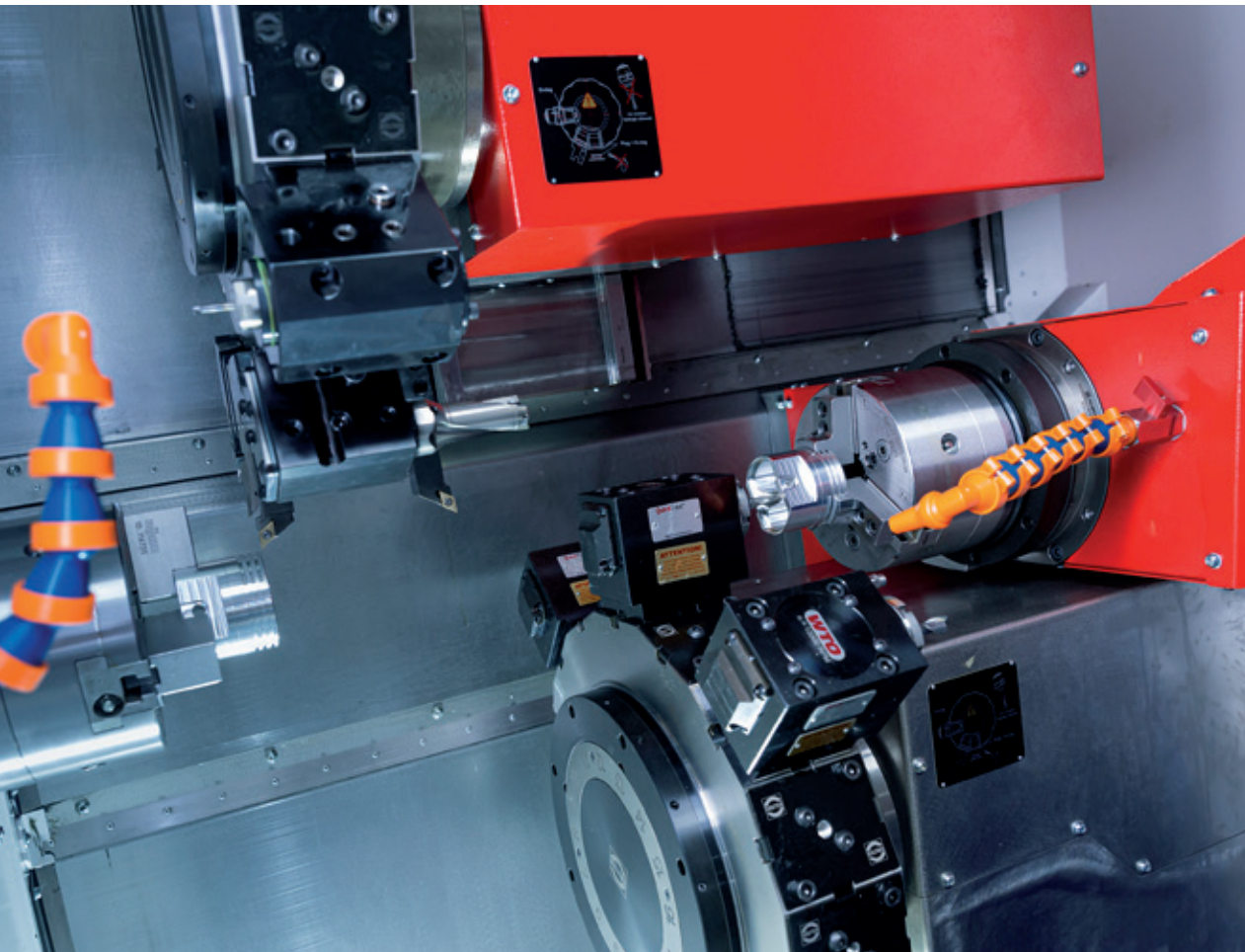

WORK AREA

The generous work area provides space for several tools on both turrets and ensures a continuous chip flow even during virtually unmanned production. Additional coolant pumps and a sophisticated pipe system clear the chips into the chip conveyor.

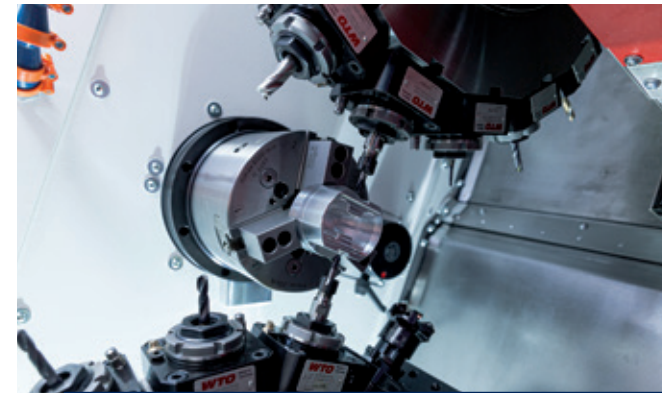

MAIN SPINDLE

The 15 resp. 18 kW motor spindle with its integrated water cooling system provides high dynamics but low thermal displacement. A high-resolution shaft encoder provides the optimum conditions for accurate contour milling and drilling.

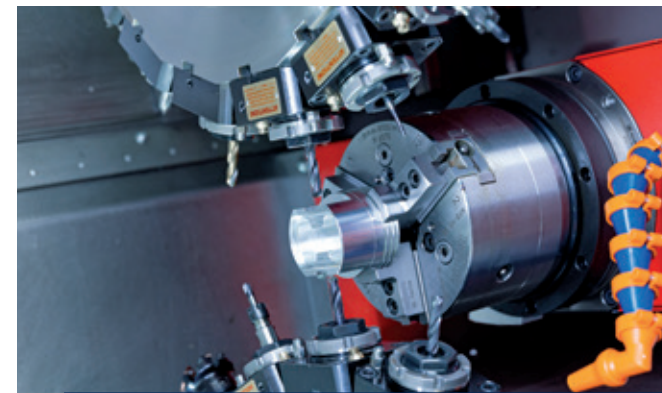

COUNTER SPINDLE

A 15 kW, water-cooled spindle motor ensures dynamic performance and high levels of precision. The standard machine is equipped with a coolant-fed parts ejector. This places the finished workpieces in the parts catcher and at the same time clears the clamping surface from chips. Additionally, a flexible coolant pipe is mounted above the counter spindle for cleaning.

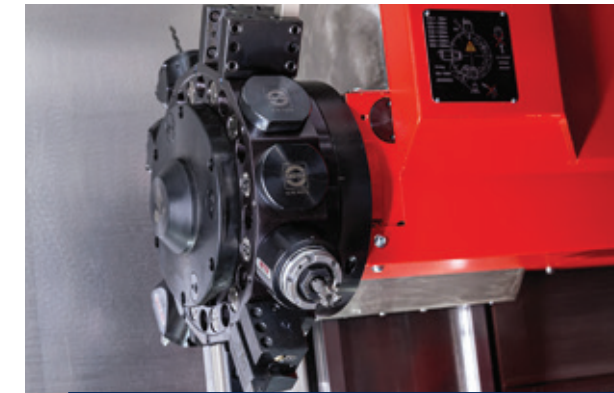

TOOL TURRETS

Rapid 12-fold servo turrets with very short cycle times for standardised VDI25 tools. All stations may accommodate driven tool holders for drilling, milling or thread-cutting operations. The operator may influence the swing speed at any time.

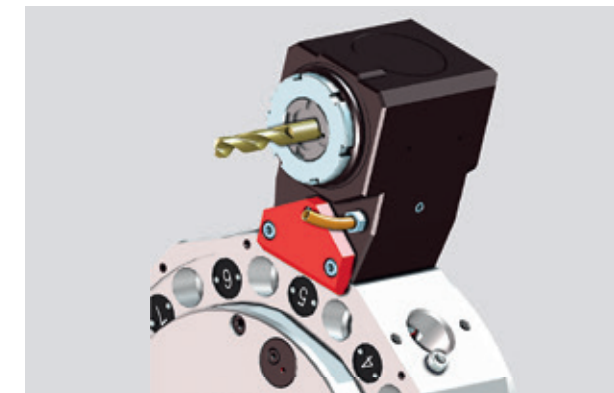

TOOL ALIGNMENT PLATE

The angled workpiece holders provided by EMCO are delivered along with a precise alignment plate. Thus, it is not required to align the holders in the machine. The parallelism of the locating bore to the main spindle axis is guaranteed by the precise adjustment plate attached to the holders.



BMT-TURRET

For economical production of complex turned/milled parts with mainly milling share, there is optional the BMT-turret with water cooled direct drive. With max. 12000 rpm, 21 Nm and 8 kW, this turret offers optimal prerequisites for the complete machining.

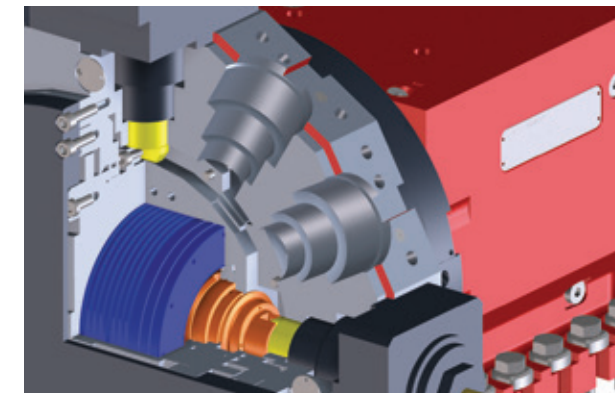

BMT-TURRET WITH DIRECT DRIVE

The milling drive engages directly with the drive shaft of the respective mill holders. This creates a high-performance in-line drive without disadvantageous gearing mechanisms. What is more, the BMT interface guarantees maximum repetition accuracy when the tool heads are lowered. Fixed with 4 screws, it guarantees maximum stability.

HIGHLIGHTS

- / Large work area
- / Highly dynamic drives in all axes
- / Two powerful work spindles
- / 12-station / 16-station tool turret with impressive milling performance
- / Stable Y-axis with 80 mm travel
- / EMCONNECT process assistant for Sinumerik ONE
- / Fanuc 31i-B Plus with 22" multi-touch screen
- / Compact dimensions
- / Made in the Heart of Europe

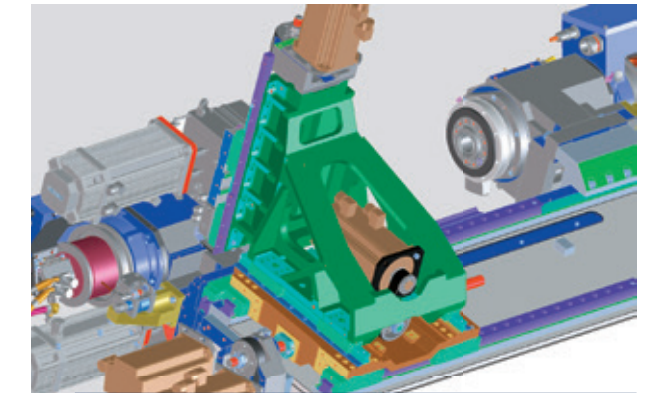

Y-AXIS

The Y-axis is integrated into the basic machine structure and stands at 90° to the X-axis. Extremely short projections form the basis for solid turning and drilling operations and also for milling operations without interference contours.

TECHNICAL HIGHLIGHTS



ERGONOMICS

Ergonomically arranged on the right-hand side of the workroom, the operating panel makes it possible to operate the HYPERTURN 50 conveniently. The operating panel is height-adjustable within a range of +/- 100 mm and may moreover be rotated by up to 50°. The screen has a 12° tilt, which ensures glare-free work in production environments with bright ceiling lights.

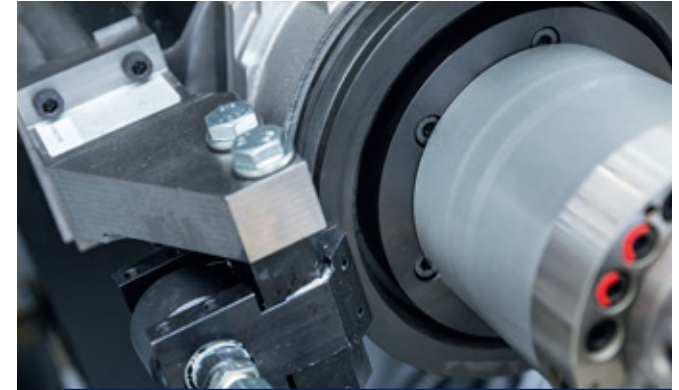

HOLDING BRAKE ON THE MAIN AND COUNTER SPINDLE

It is always the respective C-axis which is positioned for milling and drilling operations. Additionally, however, it is possible to clamp each spindle in any position.



PARTS EJECTOR ON THE COUNTER SPINDLE

The parts ejector on the counter spindle is used to push the finished part into the collection tray. It includes a function for monitoring the front end position. What is more, the ejection tube is flushed with coolant to clean the clamping device / workpiece.



WORKROOM RINSING SYSTEM

Flexible coolant hoses on the main and counter spindle as well as additional rinsing nozzles in the workroom ensure an optimal chip flow.



COMPRESSED AIR PISTOL

Located on the side of the machine, the spiral hose with compressed air pistol can be used to clean workpieces, clamping devices and workpiece holders.



CLAMPING STROKE CONTROL ON THE MAIN AND COUNTER SPINDLE

Thanks to the programmable clamping stroke control, the clamping positions of the two clamping cylinders can be easily taught in. As a consequence, handling works on the cylinders are no longer required. This leads in turn to shorter set-up times.



WORKROOM COVERS

Sliding plates with special scrapers in the work area ensure low wear and flawless operations.



MAINTENANCE CENTRE

The central maintenance unit is located behind the main spindle, where the maintenance work is carried out in a time-saving manner.



VALVE BLOCK FOR ADJUSTING THE CLAMPING PRESSURE

The valve block for adjusting the clamping pressure is located in the side panel, right at the front on the left-hand side. The clamping pressures are displayed digitally, and the pressure switches can be easily taught in. Programmable clamping pressure adjustment is available as an option.

NETWORKS ARE CREATED INDIVIDUALLY – OUR SOLUTIONS AS WELL

Staying in touch is not only important for people. Staff, machines and the production environment must also be securely networked with each other to ensure an efficient production process. With EMCONNECT, the machine is optimally equipped for this. In addition, EMCONNECT Digital Services provides innovative online services to optimise machine operation. The machine data form the basis for a wide range of applications. In this way, the user has the status of the machine available at any time and in any place.



Control panel as central platform

With EMCONNECT, the machine control panel becomes a central platform with access to all necessary applications, data and documents. Remote Support, Web Browser and Remote Desktop offer a wide range of connection options, even outside the direct production environment. The optional OPC UA interface allows data exchange with the IT system environment and interaction with other machines for shop floor automation. In this way, EMCONNECT makes an important contribution to highly efficient machine operation.



Innovative online services

With EMCONNECT Digital Services, all interested users have online access to the current status and evaluations of the machine. Automatic notification in the event of malfunctions or machine stoppages and extended diagnostic options for remote maintenance reduce downtimes and machine downtime to a minimum. Integrated maintenance management supports predictive maintenance based on machine utilisation. Thanks to the continuous development of online services, new functions are always available.

Integration into the control

EMCONNECT offers options for situation-dependent operation. Apps can also be used in parallel with the control system. With optimal integration into the NC control system, EMCONNECT complements the NC control with powerful functions for modern control generations (SIEMENS, HEIDENHAIN, FANUC). The familiar vision of the machine NC control is maintained at all times.



An innovative concept

These powerful apps may be used independently from the control, while in the background the machine is busy in the production process. With only one click, you can change at any moment between numerical control and EMCONNECT. This is possible with the help of an innovative and ergonomic control panel, equipped with a modern 22" multi-touch display, an industrial PC with associated keyboard and HMI hotkeys.



EMCONNECT HIGHLIGHTS AND FUNCTIONS

- / Fully networked**
Remote access to office computers, web browsers and online services with all applications and users connected
- / Structured**
Clear monitoring of the machine state and the production data
- / Customized**
Open platform for modular integration of customer-specific applications
- / Compatible**
Interface for seamless integration into the operating environment
- / User-friendly**
Intuitive and production-optimized touch operation data
- / Future-proof**
Continuous extensions as well as easy updates and upgrades

Standard-Apps

Control	Dashboard	Machine Data
System	Maintenance Manager	Digital Services
Remote Desktop	Settings	Web Browser
Remote Support	TeamViewer	Service
Cutting Calculator	Calculator	Notes
Backup & Restore	File Import	Documents
GD&T	EMCO TechSheet	Thread Reference



Optional

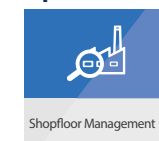



/ Ing. Johann Brisker
Brisker GmbH

"All EMCO turning machines are automated with short bar or bar loaders, which frees up employees for other tasks and, as a consequence, increases productivity."

/ The EMCO short bar loaders. Universal and powerful.



SHORT AND TO THE POINT.

The EMCO SL 1200 is the perfect solution for automatic feeding and loading of cut-to-length bars. The key advantages are a small footprint and rapid loading times resulting from shorter strokes.

The technology. The SL 1200 can be used immediately as a "plug-and-play" solution. Their extremely small footprint enables processes to be automated even if space is tight. Apart from complying with the latest safety requirements, it is easy to operate and moveable

for service purposes. Besides, it can comfortably be incorporated into the production process using the machine control's programme input masks. Minimum setup efforts are required when switching over to other bar diameters.



EMCO SL 1200

Space-saving and cost-effective bar loading magazine. Operation and programming could not be easier. May also be used for loading single items through the lathe's main spindle.

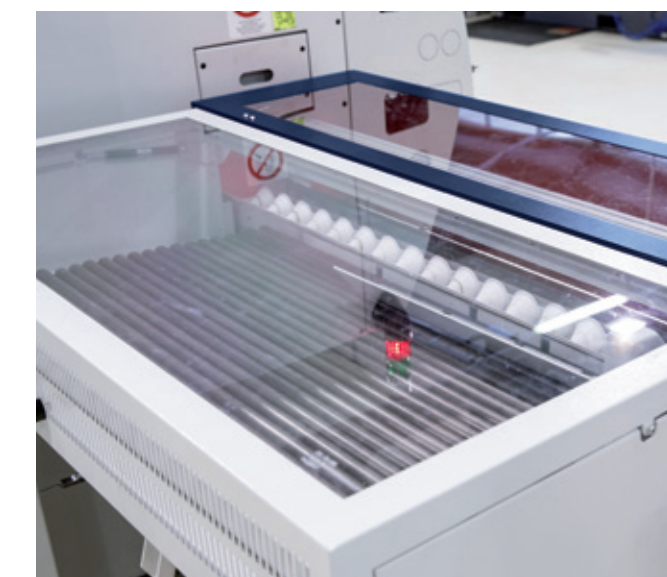

Material storage

The material storage surface with a length of 560 mm is arranged at the rear of the bar loader in a manner with no influence whatsoever on the space available. Depending on the diameter it is possible to store a different number of short bars.

THE BENEFITS

- / Small footprint
- / Easy to use
- / Short feed times
- / Fast, straightforward changeover
- / Option to load individual workpieces
- / Central diameter adjustment
- / The loader operates without oil
- / Ergonomic EMCO design

Technical data	SL 1200
Bar diameter	Ø 8 – 95 mm
Max. bar length	1200 mm
Min. bar length	150 mm
Max. bar weight	45 kg
Material storage length	approx. 560 mm
Feed rate	0 – 60 m/min
Bar change time	approx. 15 sec.
Dimensions (L x W)	1700 x 1250 mm
Weight	approx. 500 kg

THE EMCO SWING LOADER. THE INTEGRATED SOLUTION.

Tailor-made solutions. For preformed blanks and parts with a diameter larger than the spindle capacity, we offer an integrated swing loader for fully automatic loading and part removal. This has been designed to form a harmonious single entity with the machine. The machine control system takes care of positioning. A short bar loader and a 3-meter bar loader are available from EMCO for workpieces from bar stock.



ADVANTAGES

- / Fully automated loading and unloading of the workpieces
- / Short loading and unloading time
- / Flexible for shaft or flange parts
- / Oriented loading into the clamping device
- / Simple programming via the Sinumerik control
- / CNC-controlled movements

MAXIMUM OUTPUT – MINIMUM SPACE REQUIRED.

The EMCO swing loader is a universal loading system for all types of preformed blanks. It can be customized individually to the customer's requirements using numerous gripper and handling systems. How we do it: we standardize the components but create a customized solution. The result: a custom-tailored machine for the same price as a standard unit.

Blank feeding systems, gripper and handling systems

Feed systems specific to particular blanks allow preformed workpieces to be loaded in the working spindle correctly oriented, which enables economical unmanned operation.

A wide range of gripper and handling systems.



Large storage capacity chain feeding system for loading preformed blanks with the correct orientation.

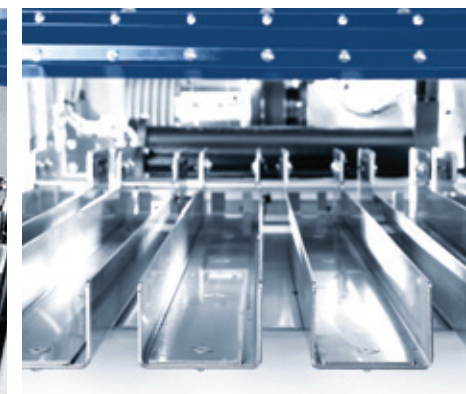

Multiple infeed chutes for loading rotationally-symmetrical blanks. The length of the blanks determines the number of infeed chutes.



Chain feeding system with V-supports for preformed shaft parts of various shapes.

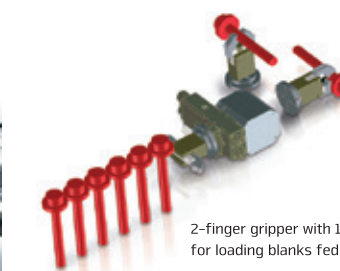

2-finger gripper with 180° rotary module for loading blanks fed in vertically

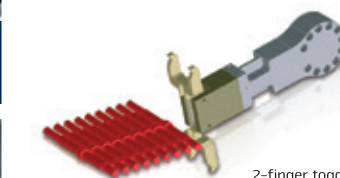

2-finger toggle lever gripper for loading shaft parts



Multiple infeed chutes for loading rotationally symmetrical blanks. A sensor monitors the availability of blank parts for each infeed chute.

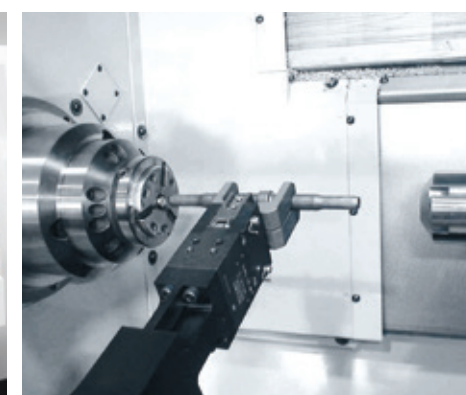

Shaft gripper for automatically loading preformed shafts.



Fully automatic shaft loading. Feed-in via a conveyor belt, removal via the finished parts pick-up device.

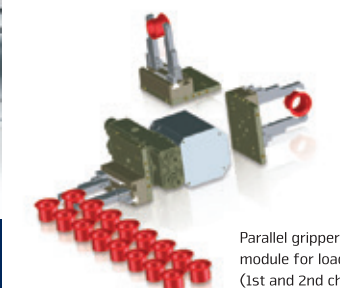

Parallel grippers with 180° rotary module for loading shaft parts (1st and 2nd chucking)

THE EMCO GANTRY LOADER. INDIVIDUAL PROCESS OPTIMIZATION.

- 1 GANTRY LOADER
- 2 PALLET MAGAZINE (with 20 stations)
- 3 GRIPPER SYSTEM



ADVANTAGES

- / Fully automatic loading and unloading of the workpieces
- / Multi-channel Sinumerik control incl. user cycles
- / Seamless interplay between the machine tool and the loading device
- / Varied possibilities of customer-specific adaptation
- / Possibility of integration of measuring station, signing station, cleaning station, etc.
- / Short spare time due to a loading hatch

AUTOMATIC RETURN ON INVESTMENT

Workpiece magazine

Blank-specific pallet attachments enable oriented loading of blanks into the machine and increase the parts stock for unmanned production. Changeover times are reduced or eliminated thanks to the perfect adjustment to the customer's parts.



4-station pallet attachment for tees

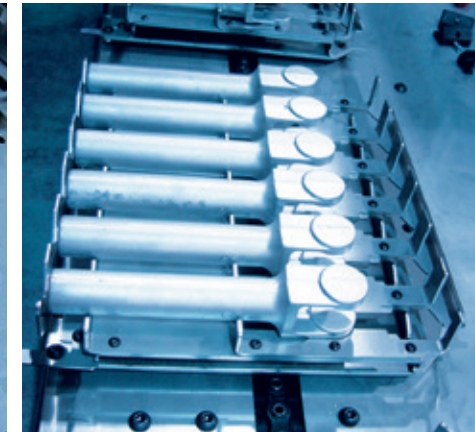

6-station pallet attachment for articulated brackets

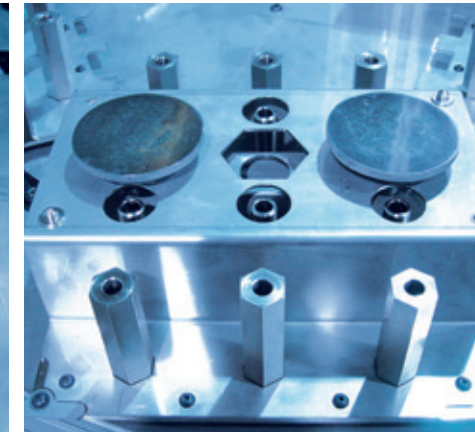

Multi-pallet attachment for a family of parts

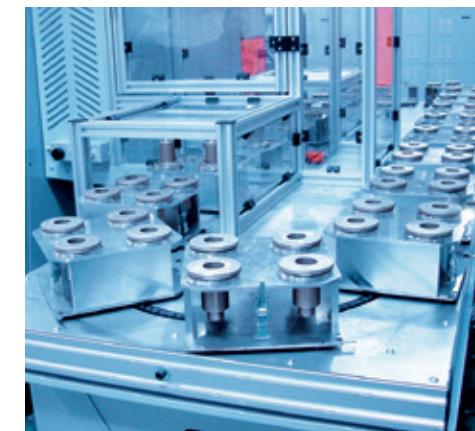

4-station pallet attachment for valve caps



20-station pallet magazine with customer-specific pallets



2 x 3-jaw double gripper head

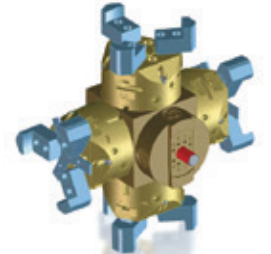

4 x 3-jaw gripper head



Shaft gripper head

OPTIONS

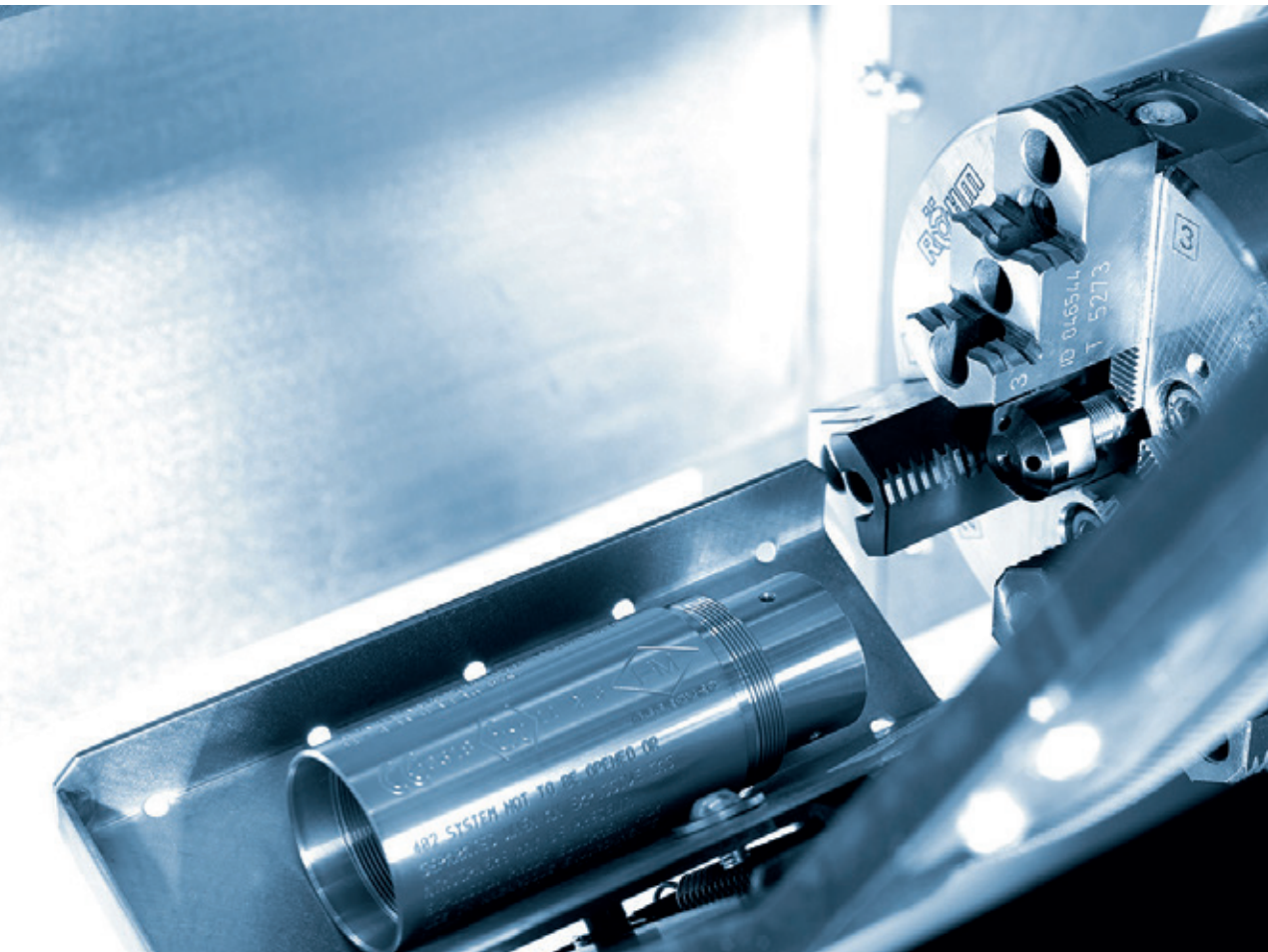

PARTS CATCHER

The HYPERTURN 50's pneumatic parts catcher is controlled using M-functions. When needed, it traverses to the front of the work area and travels to the spindle center. The finished part is removed from the clamping device and transferred to the catcher tray. The parts catcher then moves back to its initial position and the part is tipped into a catching box or onto a conveyor belt.



FINISHED PARTS CONTAINER

The parts catcher automatically transports the finished parts to a container. A parts accumulation conveyor with a usable storage surface of 340 x 750 mm is available as an option.

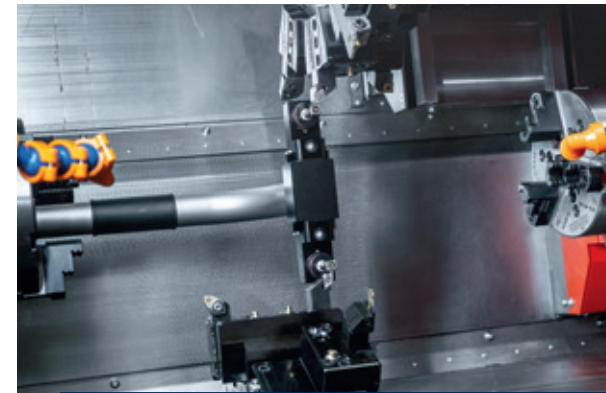

TOOL GAUGE

The tool gauge allows tools to be measured quickly and accurately on both turrets in the work area. It is mounted manually in the holder in the work area and, after use, is replaced in a storage space in the machine housing.



SPINDLE EXTENSION FOR THE SHORT BAR LOADER

The spindle extension is available for the machining of cut-to-length bars in lengths of up to 1200 mm. The cut-to-length bar stock can then be loaded into the SL1200 in a fully automated way.



OIL MIST SEPARATOR

Mechanical oil mist separator (RECOJET® -2) for separating aqueous aerosols.
Air flow: 1000 qm/h
Connected load: 250 W
Connection diameter: ø160 mm



BAND FILTER SYSTEM WITH HIGH-PRESSURE COOLANT PUMPS

A coolant pressure of 25/40/60/80 bar can be set as necessary. This enables coolant-fed drilling and milling tools to be used to their best advantage.



STORAGE SPACE FOR TOOL MEASURING PROBE

On the front left-hand side of the machine, there is a small recess where the tool measuring probe can be stored conveniently.



CLEANING NOZZLE

For cleaning the clamping devices, the covers and the entire work area. This option includes a cleaning nozzle with flow and jet adjustment as well as a solenoid valve, a key switch and a spiral hose.



AUTOMATIC DOOR

Offering maximum comfort for manual workpiece loading, the fully automatic machine door is also the prerequisite for automatic, robot-assisted loading.

MACHINE LAYOUT AND FLOOR PLAN

Machine layout HT50
with EMCO SL 1200

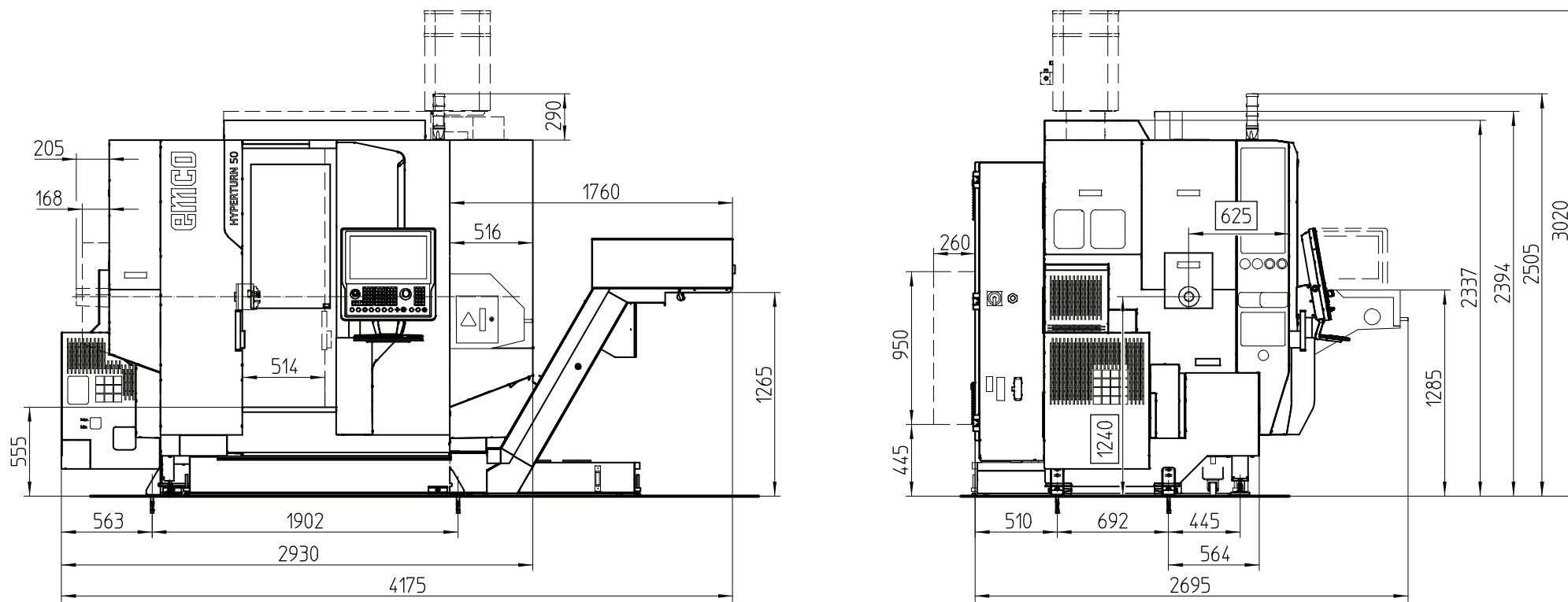

Option: - - - - -

Indications in millimetres

MACHINE LAYOUT AND FLOOR PLAN

Floor plan HT50 with EMCO SL 1200
and paper band filter system

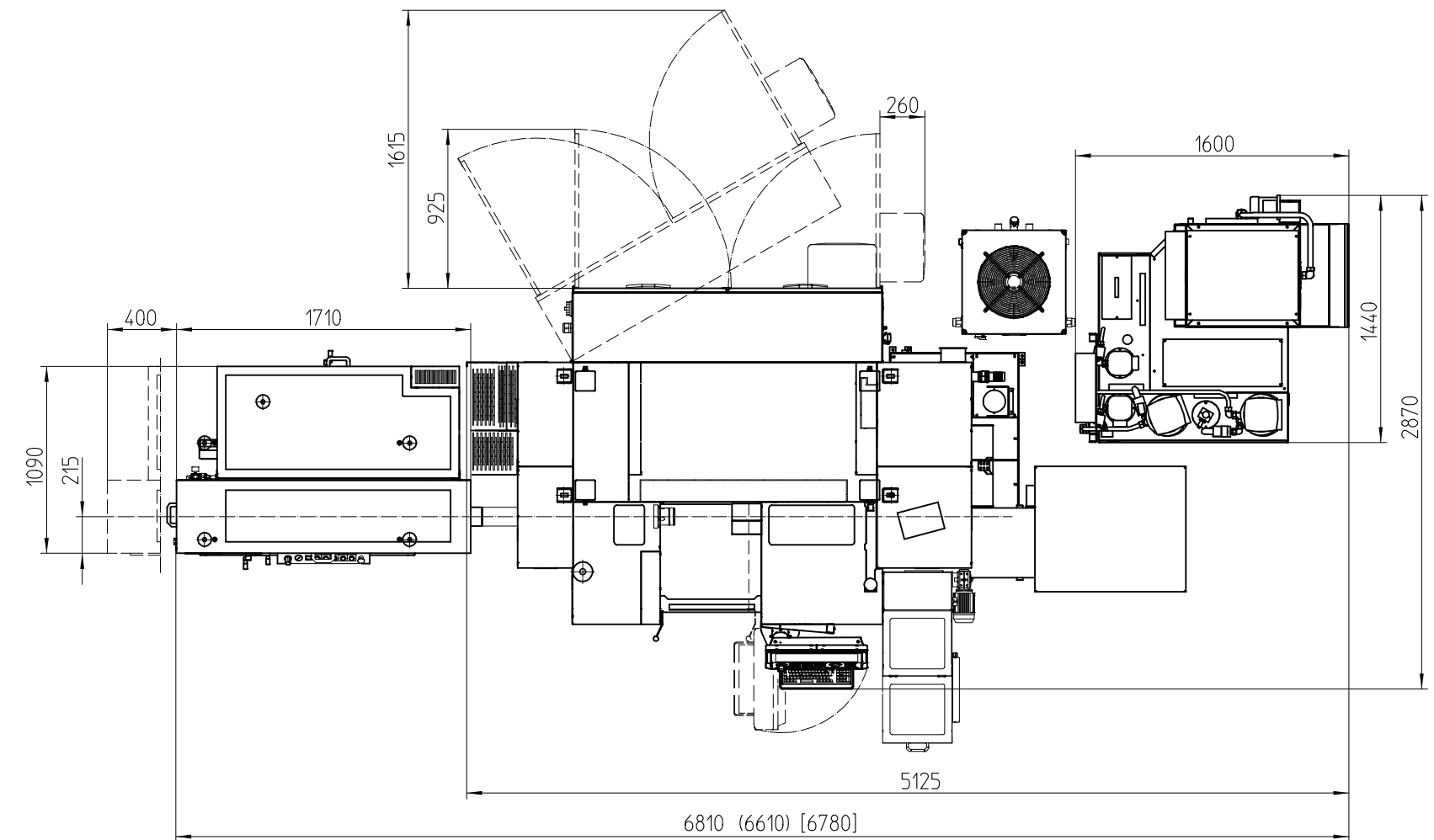

Indications in millimetres

(): Without spindle extension, []: Spindle Ø 65 - BigBore

MACHINE LAYOUT AND WORK AREA

Work area HT50 with 12-station VDI 25 turret

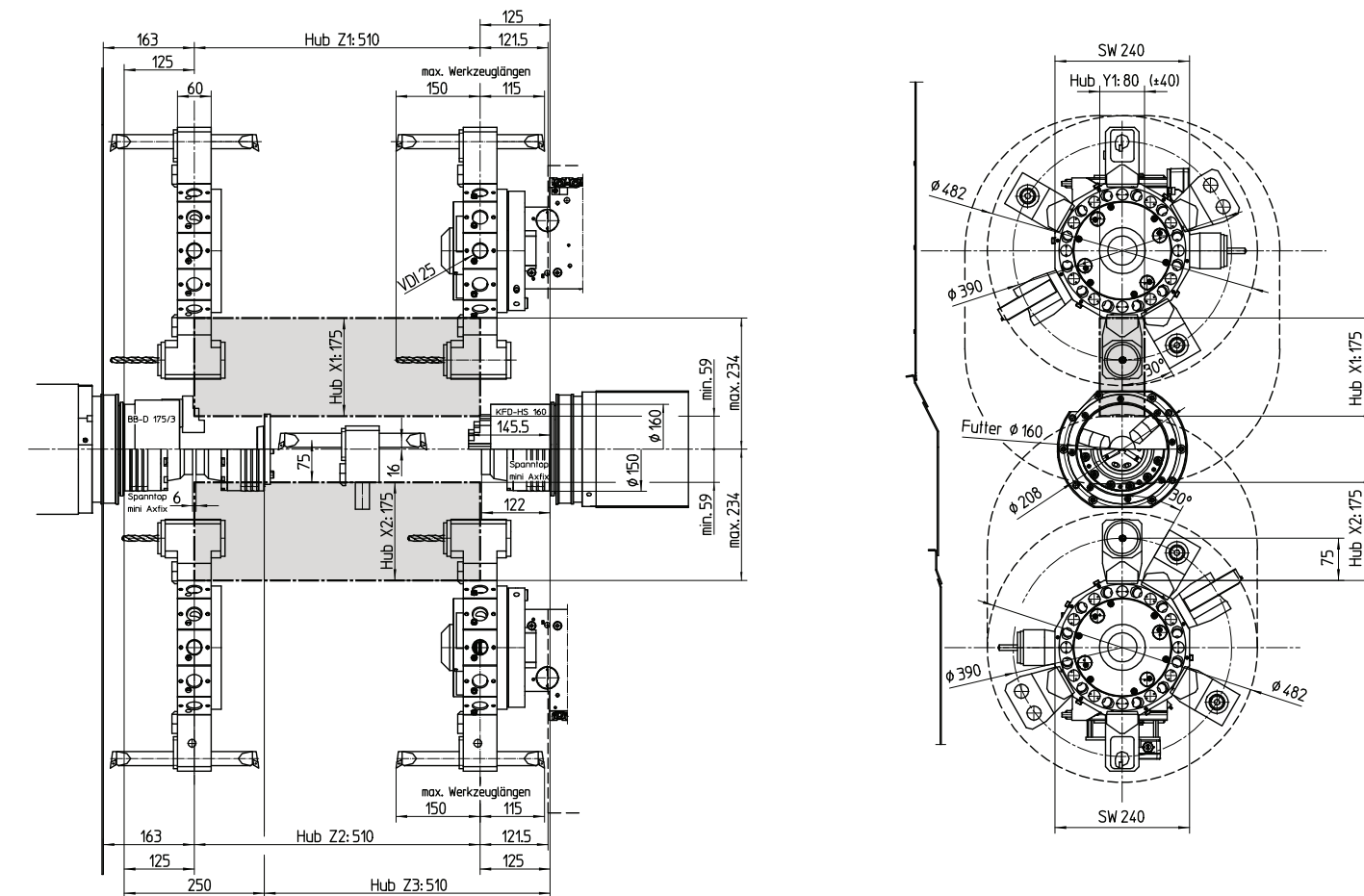

Indications in millimetres

WORK AREA

Work area HT50 with 12-station BMT45P turret

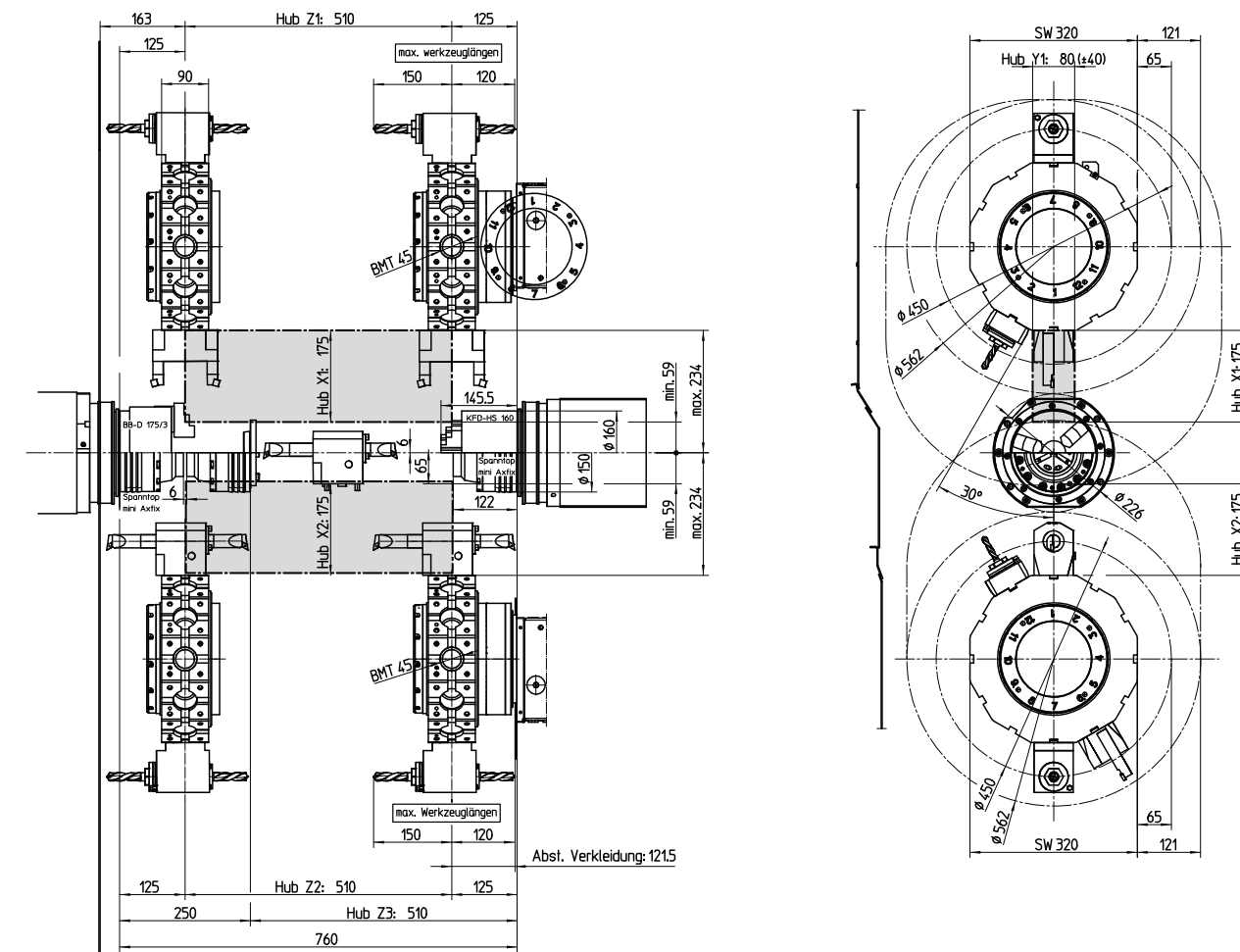

Indications in millimetres

WORK AREA

Work area HT50 with 16-station BMT45P turret

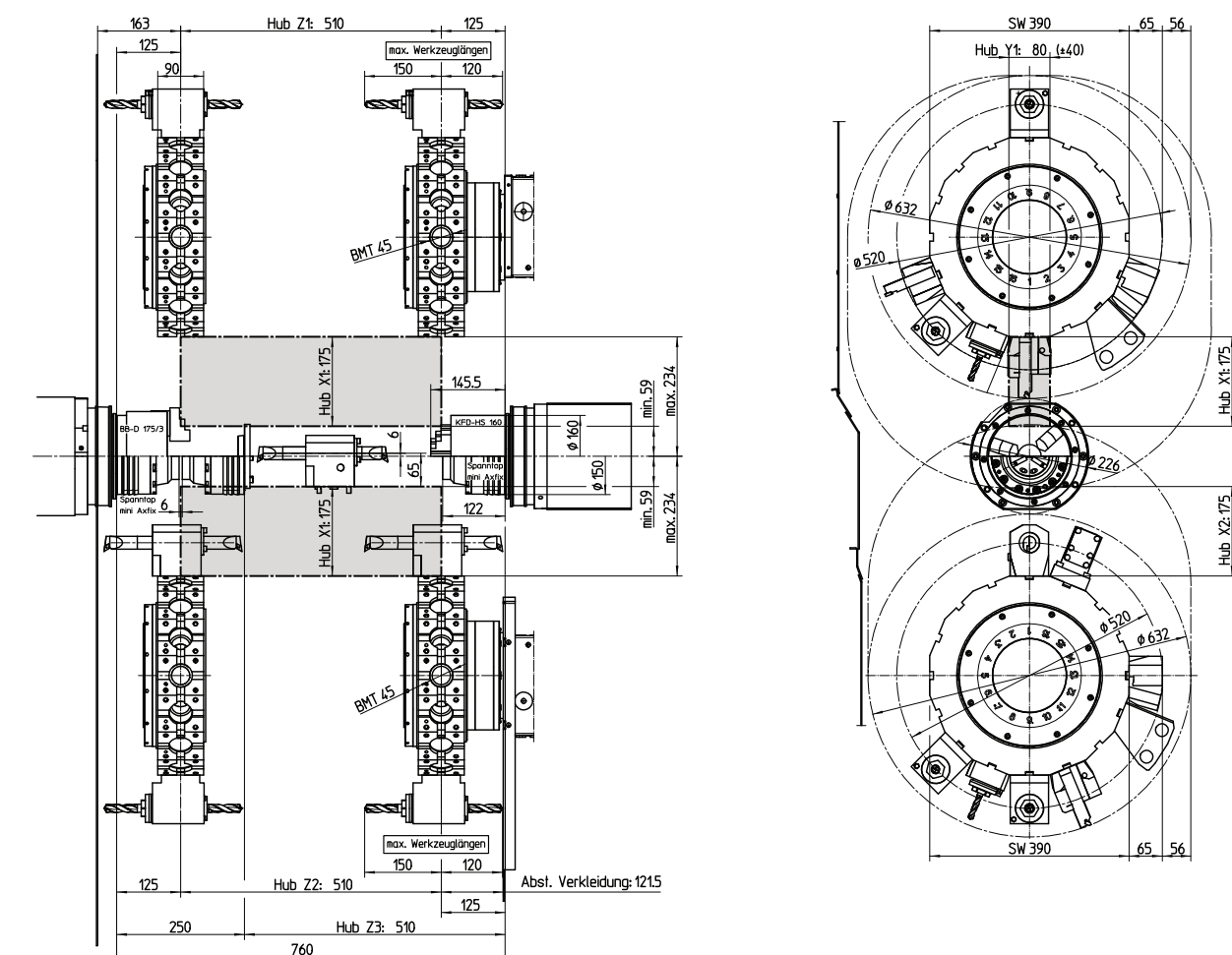

Indications in millimetres

TECHNICAL DATA

Working area

Swing over bed	Ø 430 mm
Swing over cross slide	Ø 300 mm
Distance from main spindle to counter spindle	760 mm
Max. turning diameter	Ø 300 mm
Max. part length	480 mm
Max. bar capacity	Ø 51 (65) mm

Travel

Slide travel in X / X2	175 / 175 mm
Slide travel in Z / Z2 / Z3	510 / 510 / 510 mm
Travel in Y	+40 / -40 mm

Main spindle

Speed range	0 – 7000 (5000) rpm
Max. torque on the spindle	100 (150) Nm
Spindle nose DIN 55026	KK5 (KK6)
Spindle bearing (inner diameter at front)	Ø 85 (105) mm
Spindle bore	Ø 59 (73) mm

Counter spindle

Speed range	0 – 7000 rpm
Max. torque on the spindle	100 Nm
Spindle nose DIN 55026	KK5
Spindle bearing (inner diameter at front)	Ø 85 mm
Spindle bore	Ø 53 mm

C-axes

Resolution of the rotary axis	0,001°
Rapid motion speed	1000 rpm
Spindle indexing (disc brake)	0,01°

Drive power

Main spindle	15 (18) kW
Counter spindle	15 kW

Tool turrets, VDI / BMT

Number of tool positions	2 x 12 / 2 x 12 (16)
Tool holders	VDI 25 / BMT45 P
Tool cross section for square tools	16 x 16 / 20 x 20 (25 x 25) mm
Shank diameter for boring bars	Ø 25 / Ø 32 (40) mm
Revolver switch time	0.2 / 0.2 sec

Driven tools, VDI / BMT

Speed range	0 – 8000 / 0 – 12000 rpm
Torque	16 / 21 Nm
Drive performance	4 / 8,8 kW
Number of driven tools	2 x 12 / 2 x 12 (16)

Feed drives

Rapid motion speed X / Y / Z	30 / 15 / 45 m/min
Feed force in the X-axis / Y-axis	4000 N
Feed force in the Z-axis	5000 N
Feed force in the Z-axis, counter spindle	6000 N
Position variation Ps (VDI 3441) X / Y / Z	3 / 3 / 3 µm

Coolant system

Tank volume	230 (730) l
Coolant pumps for the tool turrets	2 x 14 bar
Flushing pumps for the work area	2 x 3,7 bar

Power consumption

Connected load	49 kVA
Supply pressure	6 bar

Dimensions/weight

Height of center above floor	1240 mm
Machine height	2340 mm
Space occupied BxT (not including chip conveyor and coolant)	2930 x 2330 mm
Total weight of machine	5900 kg

Safety devices CE compliant

beyond standard /

EMCO GmbH / Salzburger Str. 80 / 5400 Hallein-Taxach / Austria / T +43 6245891-0 / F +43 624586965 / info@emco-world.com

www.emco-world.com