

**EMCO**

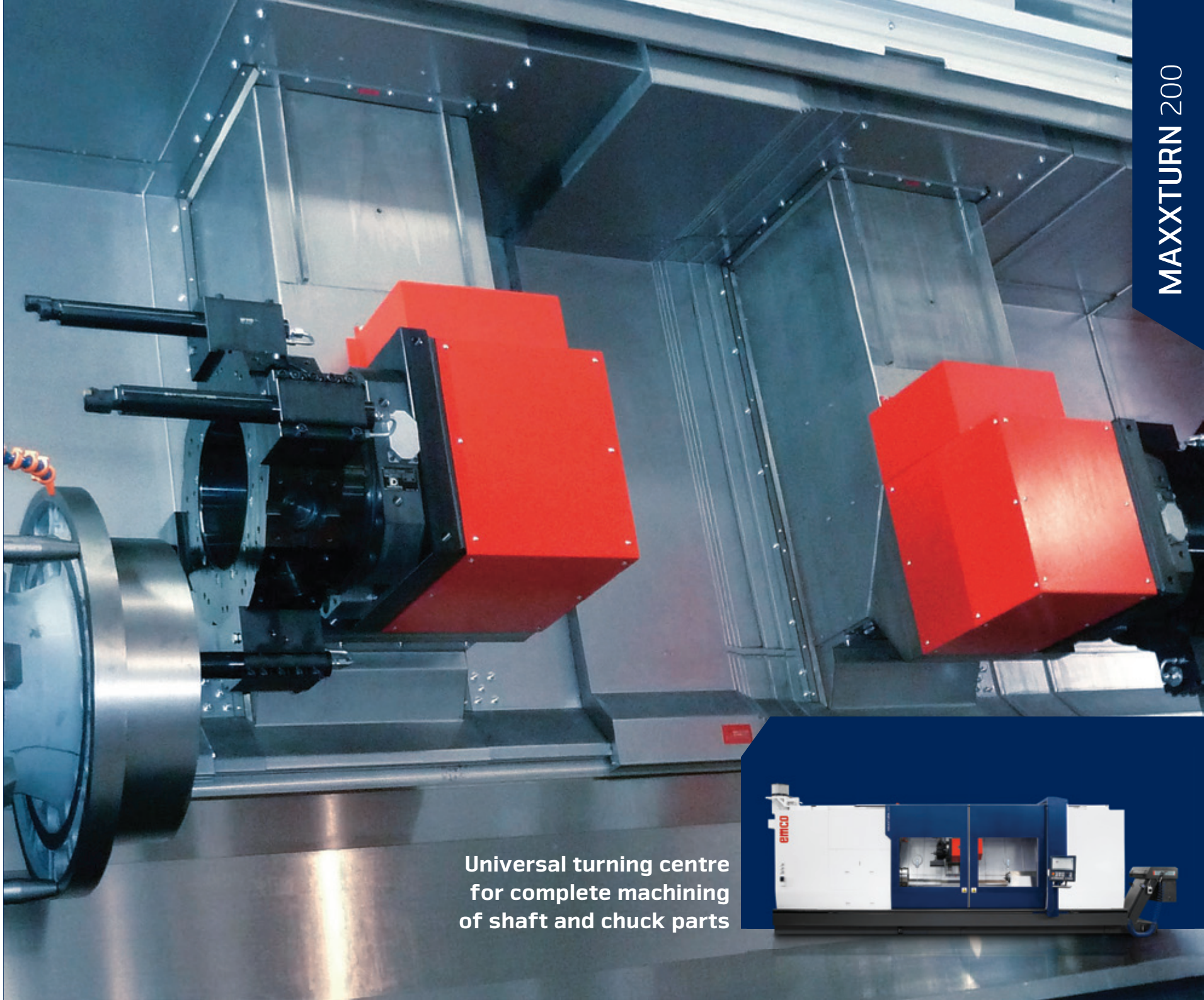

Universal turning centre  
for complete machining  
of shaft and chuck parts



**MAXXTURN 200**

# PRECISION AND STABILITY FOR HEAVY MACHINING OF LARGE COMPONENTS

The solid Maxxturn 200 heavy-duty cutting machine can be used for turning and milling operations. Parts featuring a maximum length of 6000 mm and a diameter of 1000 mm are produced with ease and high efficiency. The machine is available in the following configurations: with 2 turrets (standard or mirror-inverted version), with tailstock or equipped with a counter spindle.

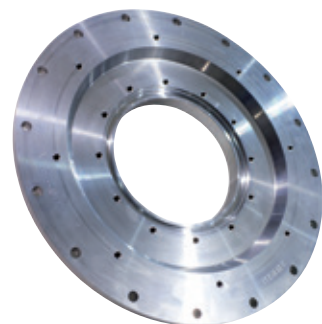

Adapter flange  
(steel, CK45)

## 1 CONTROL

- / Ergonomic, swivel-mounted and movable control panel
- / Sinumerik ONE with 22" colour display
- / Comprehensive machining cycles
- / 3D simulation
- / USB interface, 230 V socket
- / EMCONNECT
- / EMCO technology cycles (optional)

## 2 WORK ZONE

- / 3 bed lengths
- / Ideal accessibility is guaranteed by the 70-degree inclined bed and the machine concept
- / Maximum productivity thanks to 2" turret with or without Y-axis
- / Work zone and counter spindle with flush system
- / Maximum flexibility thanks to several turret concepts

## 3 TOOL TURRET AND Y-AXIS

- / +/- 125 mm stroke
- / 90° design integrated in the machine structure
- / Wide and stable guide structure for ideal vibration damping
- / 12 driven tool positions
- / Max. Torque 116 Nm
- / Max. Power 19.8 kW

## 4 CHIP CONVEYOR

- / Hinged-slat chain conveyor with 1150 mm ejection height
- / Suitable for: long steel chips, chip balls, woolly chips, dry and wet machining
- / With built-in coolant system
- / Paper belt filter equipped with high-pressure pumps with up to 80 bar (optional)

## 5 MACHINE BED

- / Broad distance of the guide rails
- / Largely dimensioned roller guides
- / Maximum stability
- / Maximum pre-stressing guarantees zero backlash in all directions of force
- / Slide way for the X-axis and the tailstock Z-axis too
- / Tailstock or counter spindle unit

## 6 STEADY REST SYSTEM

- / In different dimensions
- / NC steady rest or tandem steady rest
- / Easy to remove
- / Sealing air, cover and flush system included in the standard version
- / Optional: programmable pressure adjustment

## 7 TAILSTOCK (COUNTER SPINDLE)

- / NC tailstock
- / Built-in bearing for MK6 centre point
- / 200 mm quill diameter
- / 250 mm quill stroke
- / Automatic pressure monitoring of the quill position

## 8 MACHINE HOUSING

- / Comprehensive protection against flying chips
- / 100% protection against coolant leakage
- / Large door made of safety glass
- / Unobstructed view into the work zone

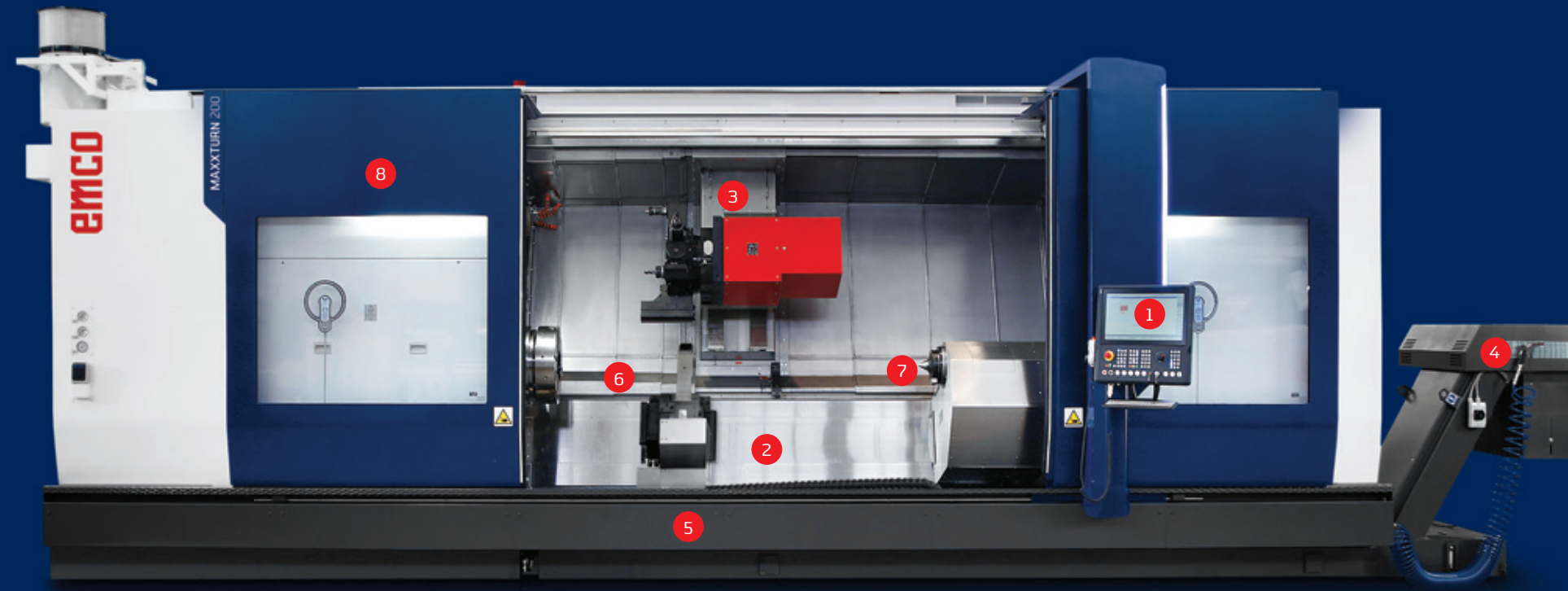

Machine with optional extras

# TECHNICAL HIGHLIGHTS

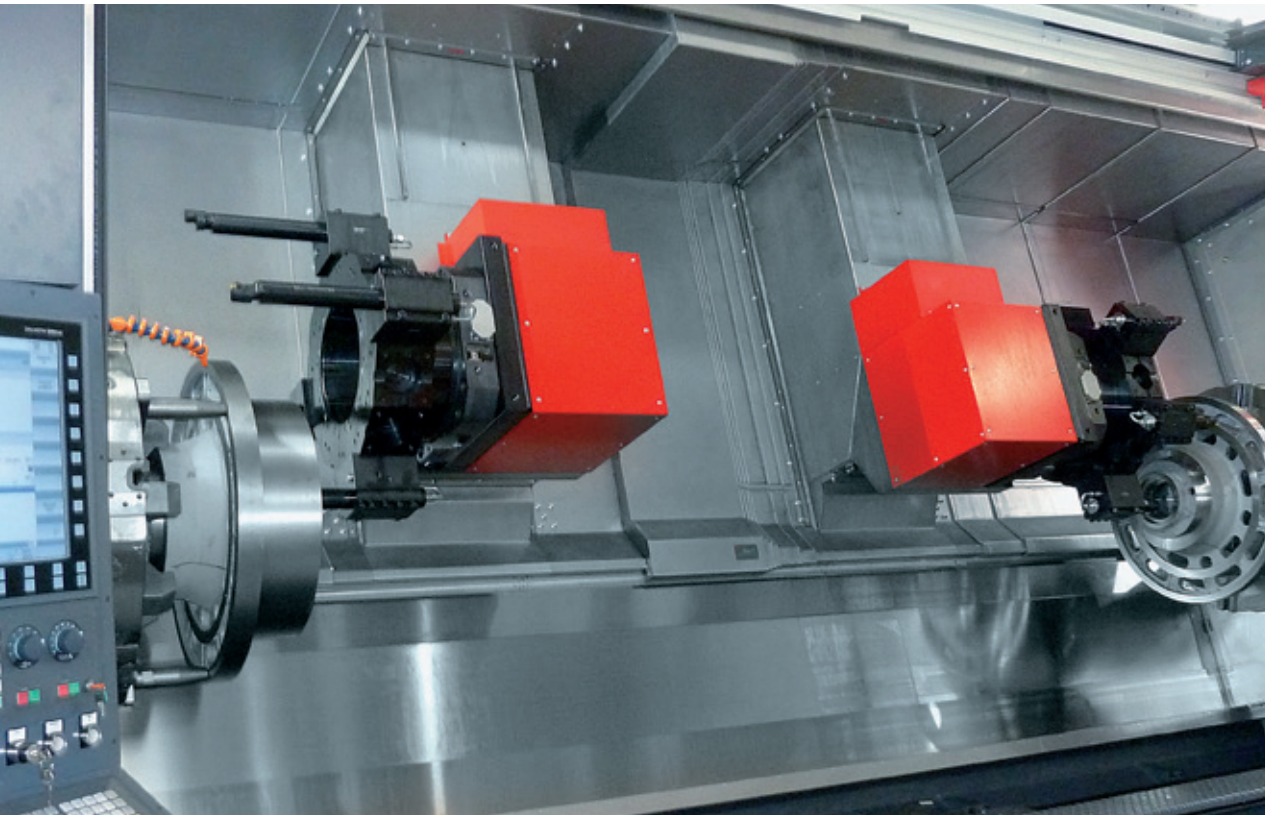

## THE MAXXTURN 200 MACHINE CONCEPT

Best turning and milling performance in all production runs. Stable machine concept that enables complete machining of long and large workpieces. The large door opening and the swivel-mounted control panel ensure ideal and ergonomic machine operation.



## MODULAR SYSTEM

The Maxxturn 200 comes in modular design. Different upgrading levels allow everything from simple turning to the expansion to a turning and milling centre with versatile application possibilities. Different spindle concepts with C-axis and high torque are used for this purpose.



## CONTROL SYSTEM

The machine is equipped with a Sinumerik ONE control. The scope of delivery includes a 22" display with state-of-the-art EMCONNECT control panel as well as versatile EMCO technology cycles (optional) for easy, dialogue-based programming.



## TAILSTOCK / COUNTER SPINDLE

The machine is equipped with an NC-controlled tailstock (optional) with integrated bearing and MK6 quill. Workpieces with a maximum weight of 6 tons are thus supported in a safe and stable condition. With the optionally available counter spindle, it is possible to manufacture workpieces in one cycle and/or two workpieces at the same time. Programmable steady rest up to Ø 680 mm for shaft parts.



## MACHINING POSSIBILITIES

Versatile machining operations are possible thanks to the BMT85 and/or VDI60 12-station turret with driven tools and block tools for large drill rods. When used in conjunction with the 80 bar belt filter system/coolant preparation, the coolant volume as well as the quality and the service life of the cutting fluid are increased.

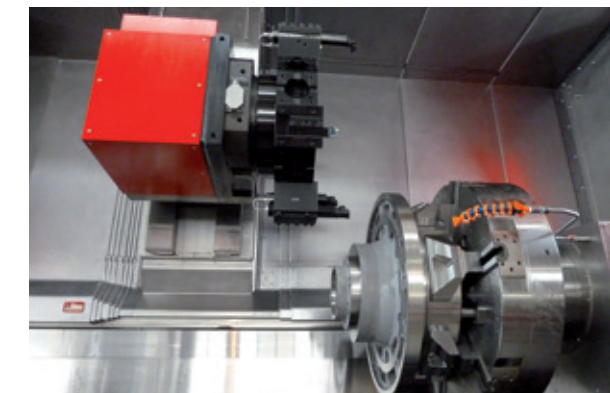

## BMT TURRET

The machine's standard equipment includes one or two BMT85 12-station turrets. With a maximum of 3000 rpm, 116 Nm and 19.8 kW, this turret creates the ideal conditions for complete machining and maximum productivity. A VDI60 12-station turret is available as an option.



## HIGH-PRECISION Y-AXES

The Maxxturn machine concept has been designed in such a way that the Y-axis is fitted at an angle of 90°. Due to large, widely spaced and prestressed linear roller guide rails, this Y-axis ensures optimum machining results with maximum stability and short projection lengths (possible for up to two turrets).

## HIGHLIGHTS

- / Extremely robust design
- / Maximum machining accuracy
- / High rapid traverse speeds
- / Stable Y-axis with large travel (MT200 +/- 125 mm)
- / NC steady rest, tailstock or counter spindle as standard
- / Hydraulic spindle brake
- / State-of-the-art control technology
- / Driven tools including C-axis
- / Simple, dialogue-based programming

# NETWORKS ARE CREATED INDIVIDUALLY – OUR SOLUTIONS AS WELL

Staying in touch is important not only among human beings. Persons, machines and the whole production environment must also be connected perfectly and safely in order to ensure efficient procedures during the production process. With EMCONNECT, the machine is optimally equipped for this purpose. The optional EMCONNECT Digital Services offer innovative online services for optimized machine operation. The user has always the control of the machine status. The automatic notification in case of malfunctions or standstill of the machine as well as the extended capabilities for remote maintenance, minimise downtimes.

## Integration into control

EMCONNECT offers several possibilities of operation according to different situations. For quick access, apps may be used simultaneously in the side panel of controlling. In this way, you can always look at your familiar numerical control, the well-known centrepiece of the machine.

## An innovative concept

These powerful apps may be used independently from the control, while in the background the machine is busy in the production process. With only one click, you can change at any moment between numerical control and EMCONNECT. This is possible with the help of an innovative and ergonomic control panel, equipped with a modern 22" multi-touch display, an industrial PC with associated keyboard and HMI hotkeys.



## The control panel as central platform

With EMCONNECT, the control panel of the machine becomes the central platform for the access to all the operative functions. The user gets every type of support from the apps, which directly provide all the necessary applications, data and documents. In this way, EMCONNECT makes an important contribution to a highly efficient processing at the machine.



## Comprehensive connectivity options

With the remote support, the web browser and the remote desktop, there are numerous connectivity options, even beyond the direct production environment. With the help of the integrated remote support, it is easily possible to carry out the remote diagnosis and remote maintenance. The optionally available OPC UA interface enables data exchange with the IT system environment and interaction with other machines for automation at shop floor level.

## EMCONNECT HIGHLIGHTS AND FUNCTIONS

- / Fully connected**  
Connection to all applications via remote control of the office computer and the web browser
- / Structured**  
Clear monitoring of the machine state and the production data
- / Customized**  
Open platform for modular integration of customer-specific applications
- / Compatible**  
Interface for seamless integration into the operating environment
- / User-friendly**  
Intuitive and production-optimized touch operation data
- / Future-proof**  
Continuous extensions as well as easy updates and upgrades

## Standard Apps

Control	Dashboard
Machine Data	System
Remote Desktop	Web Browser
Remote Support	Settings
Cutting Calculator	Calculator
Notes	Service
Documents	EMCO TechSheet
GD&T	File Import
Shopfloor Data	Thread Reference
	Tricalc

## Optional

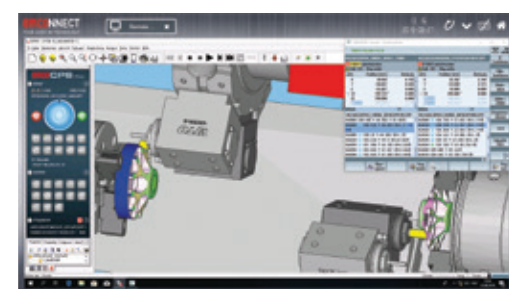
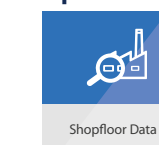

# VIRTUAL MACHINING PROCESS

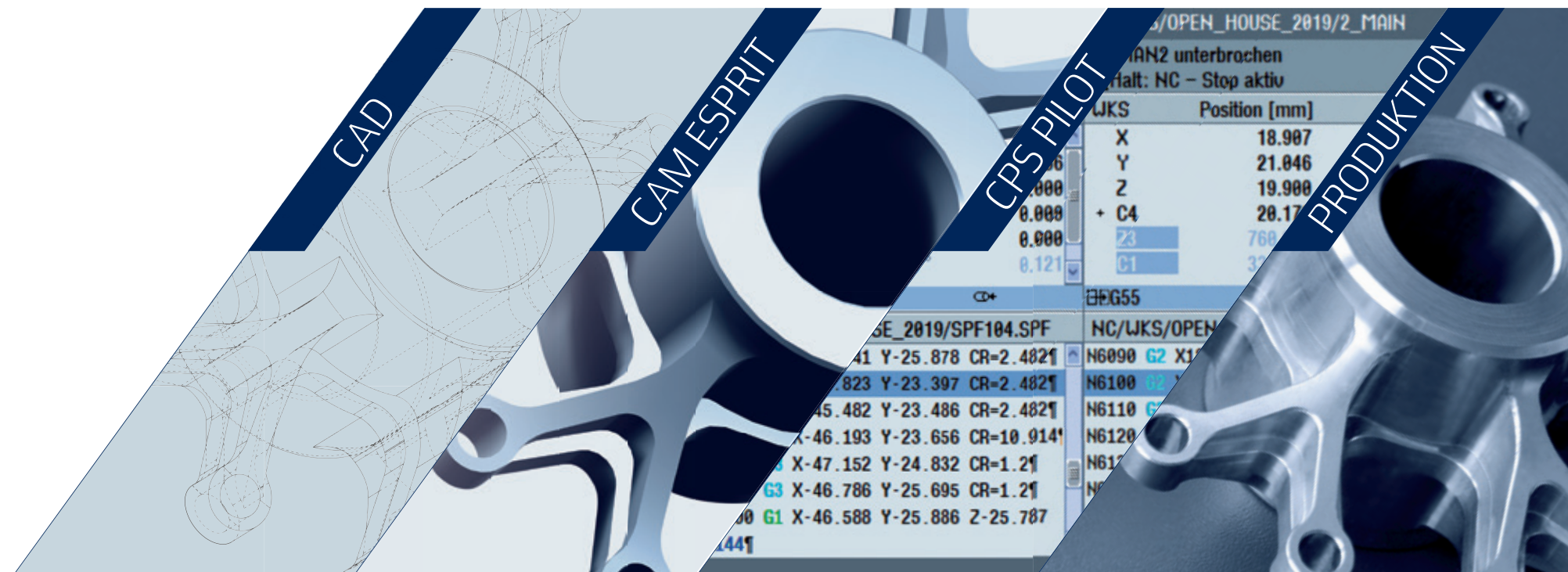

Anyone who wants to design scenarios for what is to come needs as much information as possible from different sources. EMCO's virtual workflow makes it possible to plan, simulate and optimise production processes virtually. Testing processes and training skilled workers thus works without any downtime.

- / Quick and easy from the drawing to the good part
- / Continuous digital process chain in cooperation with an experienced partner

# CONTINUOUS PROCESS CHAIN AS A PREREQUISITE FOR DIGITAL PRODUCTION

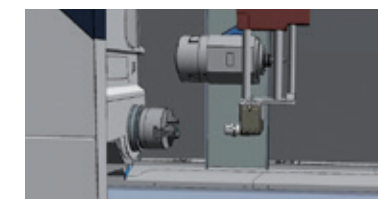
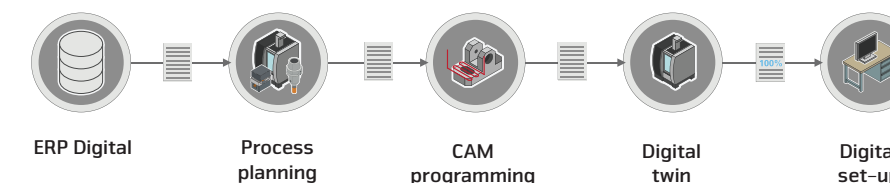

## CHECKitB4

- Simple and fast process validation of machine, fixture and tools
- / Tools can be easily guided over the workpiece - without NC code
- / Detection of collisions and axis end positions
- / No CAD /CA M knowledge required
- / Simple and innovative design of clamping situations and complete tools
- / Generation of raw parts
- / Interfaces to many CA M systems



## CPS PILOT

- Digital twin of the machine for workshop-oriented programming in work preparation
- / 100% identical with machine incl. control and machine-specific parameters
- / Original virtual control (Siemens, Heidenhain)
- / Reliable detection of collisions and syntax errors in advance
- / Interfaces to many CA M systems
- / Reduced risk and set-up times
- / Maximised machine utilisation

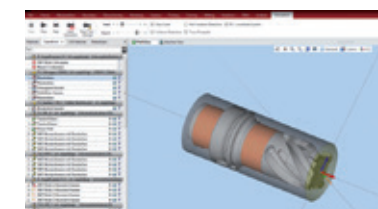

## CAM PROGRAMMING

- Program any EMCO machine:
- / Simple and fast programming of milling and multi-channel lathes.
- / Simple synchronisation of multi-channel machines
- / Quick and easy to learn
- / High-performance strategies for rough machining
- / Knowledge-based machining with partially or fully automated programming
- / Data import of any CAD system
- / Certified post-processors



## PRODUCTION

- / Reduction of set-up costs
- / Reduction of downtimes
- / Reduction of repair costs
- / Optimum machine utilisation

# MODULAR CONSTRUCTION SYSTEM

Different, standardised turret/spindle solutions are available as an option: BMT or VDI, with 11" or 15" spindle solution. Ideal performance and optimum torques for each type of machining are achieved by the perfect interplay between the mechanical components and the control.

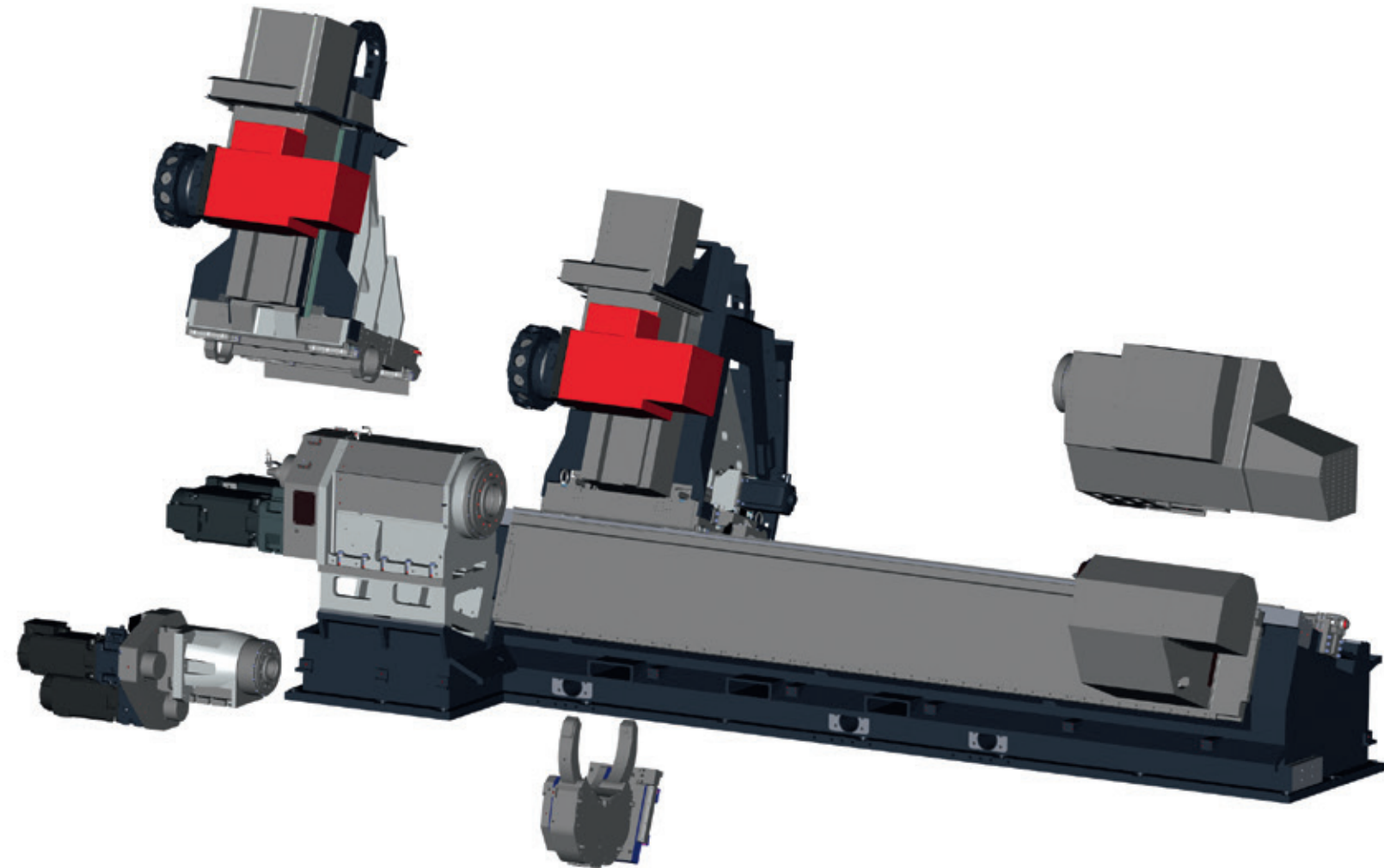

# PERFORMANCE AND TORQUE

**MT200** – The master/slave motor arrangement, which also serves as the C-axis, has been implemented **with the EMCO spindle concept**. The motors run in sync, guarantee compensation for play and make it possible to achieve the performance values and torques mentioned below (see diagrams).

Additionally, the two motors are equipped with ZF Duoplan Two-Speed Gearboxes. This results in high torques in the lower speed range and in high speeds in the upper speed range. Thus, it is possible to make optimal use of the cutting capacity provided by modern tools.

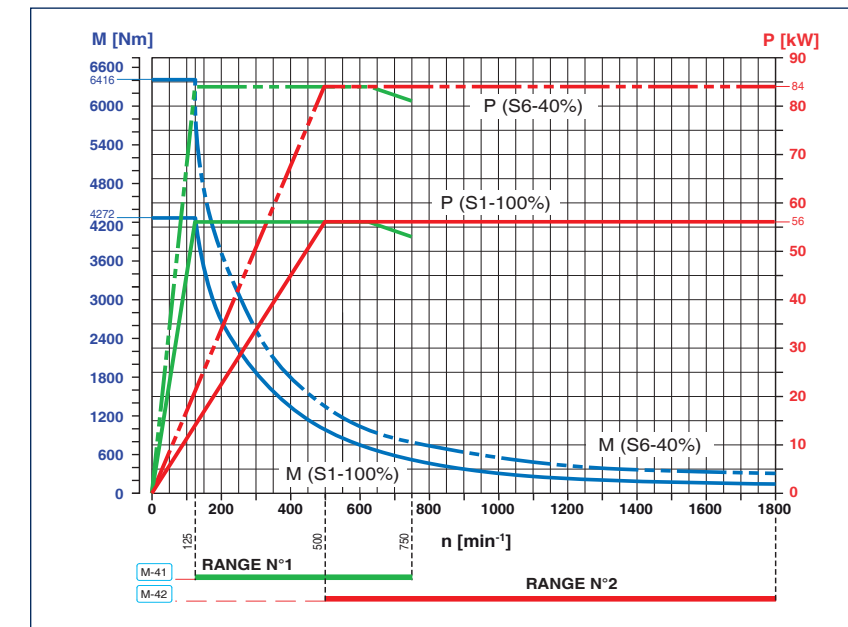

Main spindle (A2-12'')

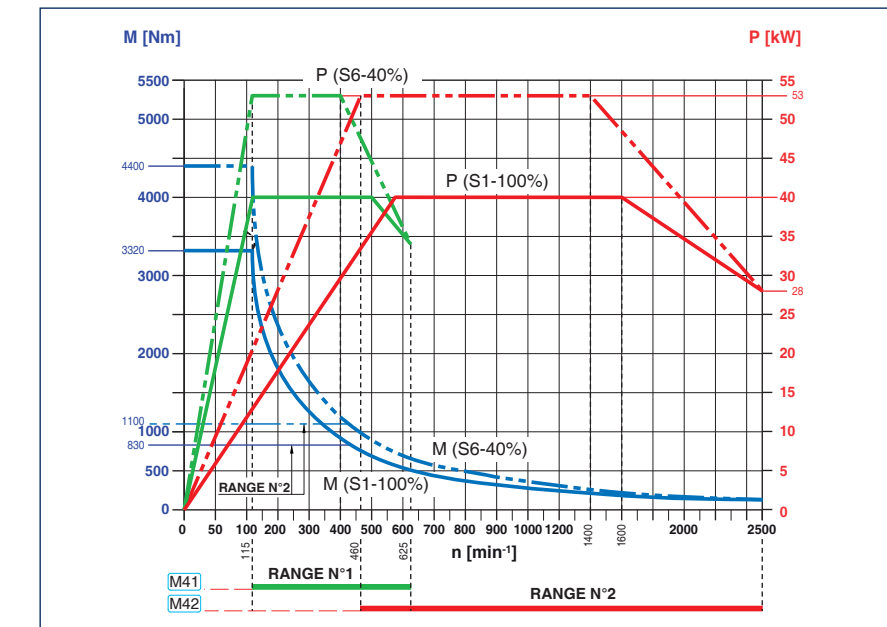

Counter spindle (A2-15'' or A2-11''), main spindle (A2-11'')

# FLOOR PLAN

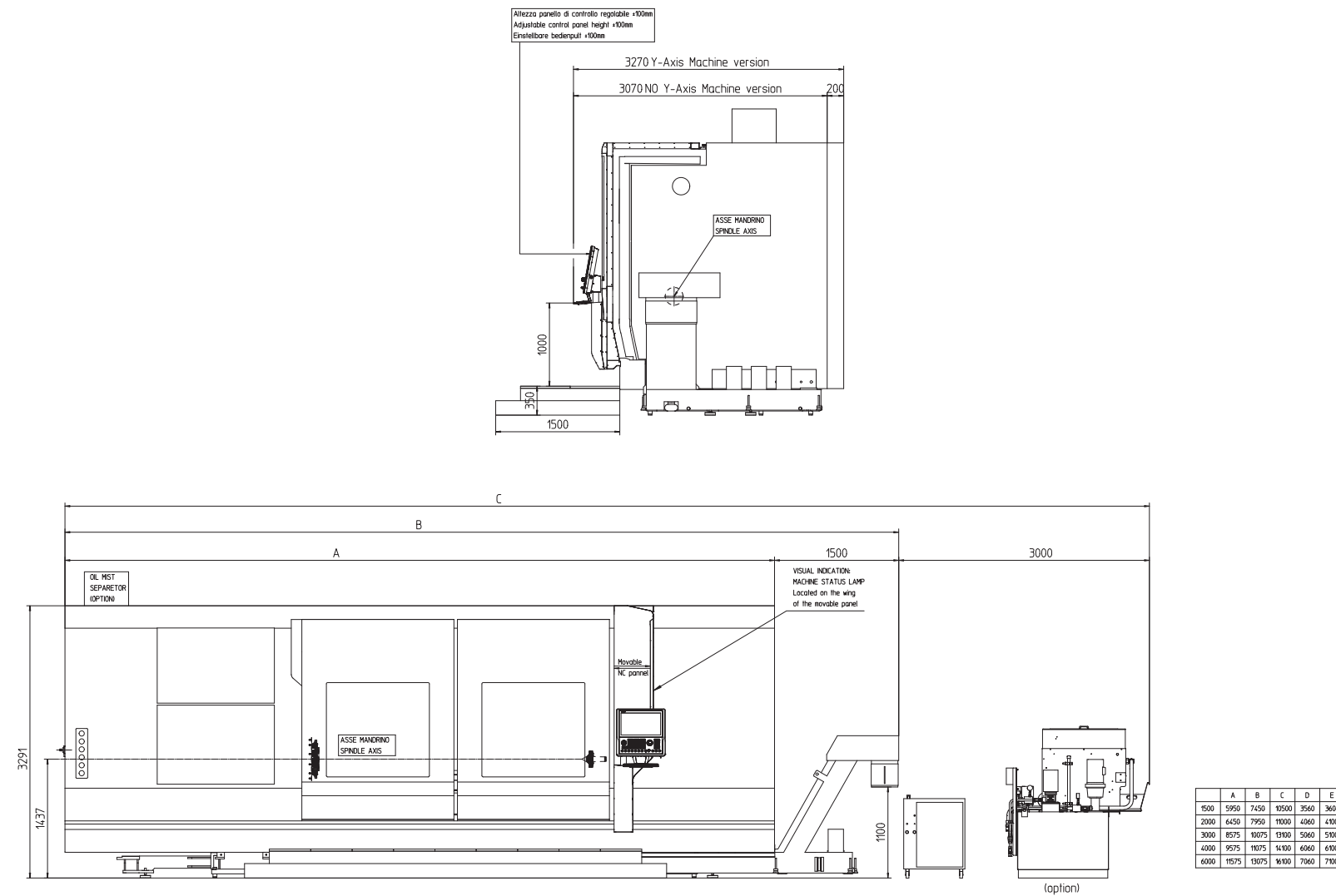

Data indicated in millimetres

# FLOOR PLAN

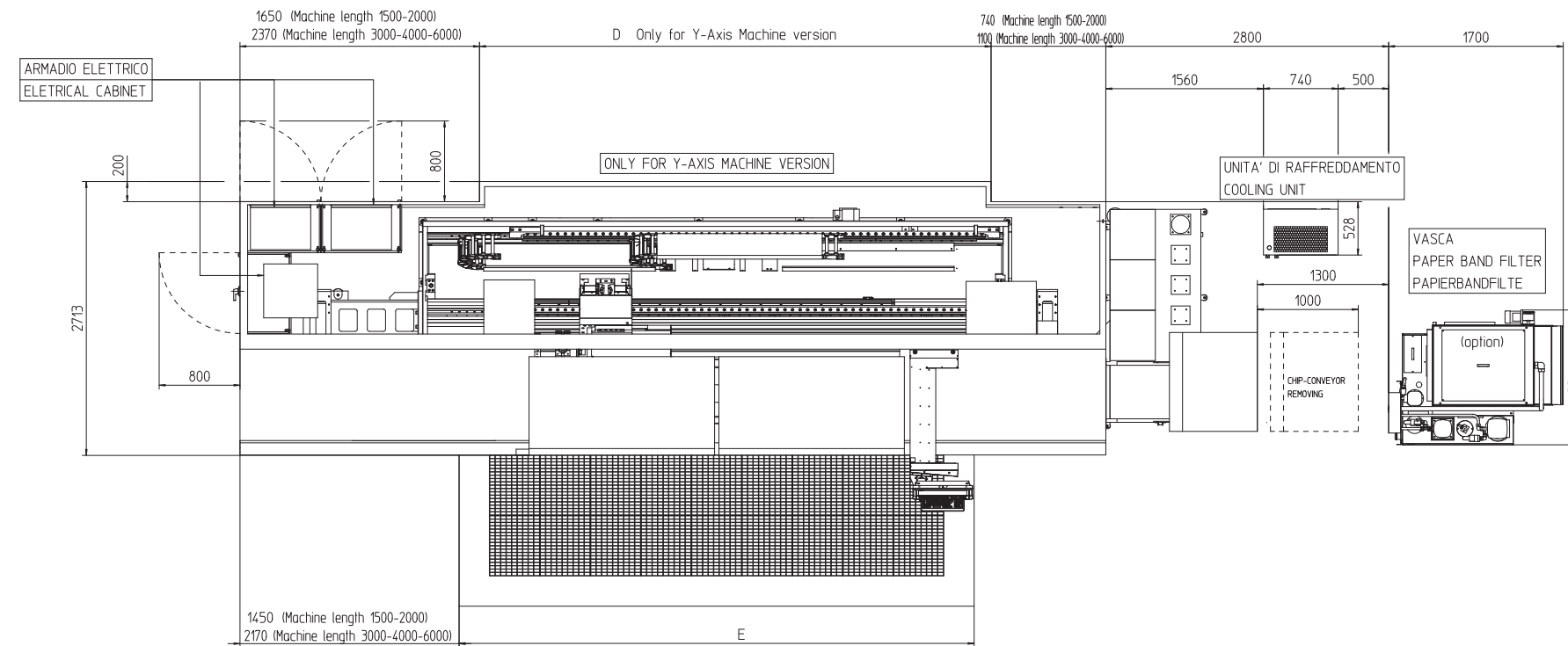

Data indicated in millimetres

# WORK ZONE

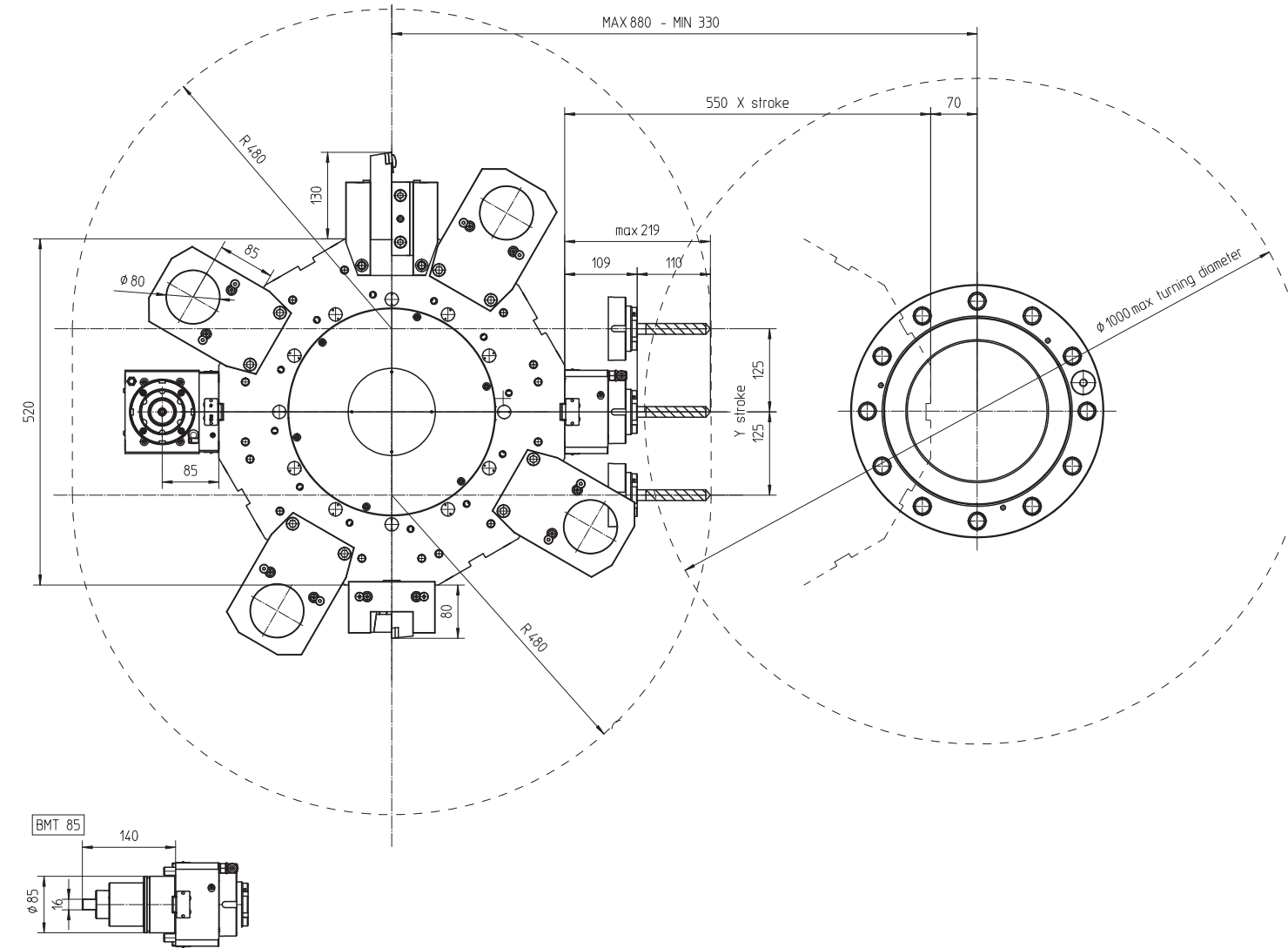

Data indicated in millimetres

# WORK ZONE

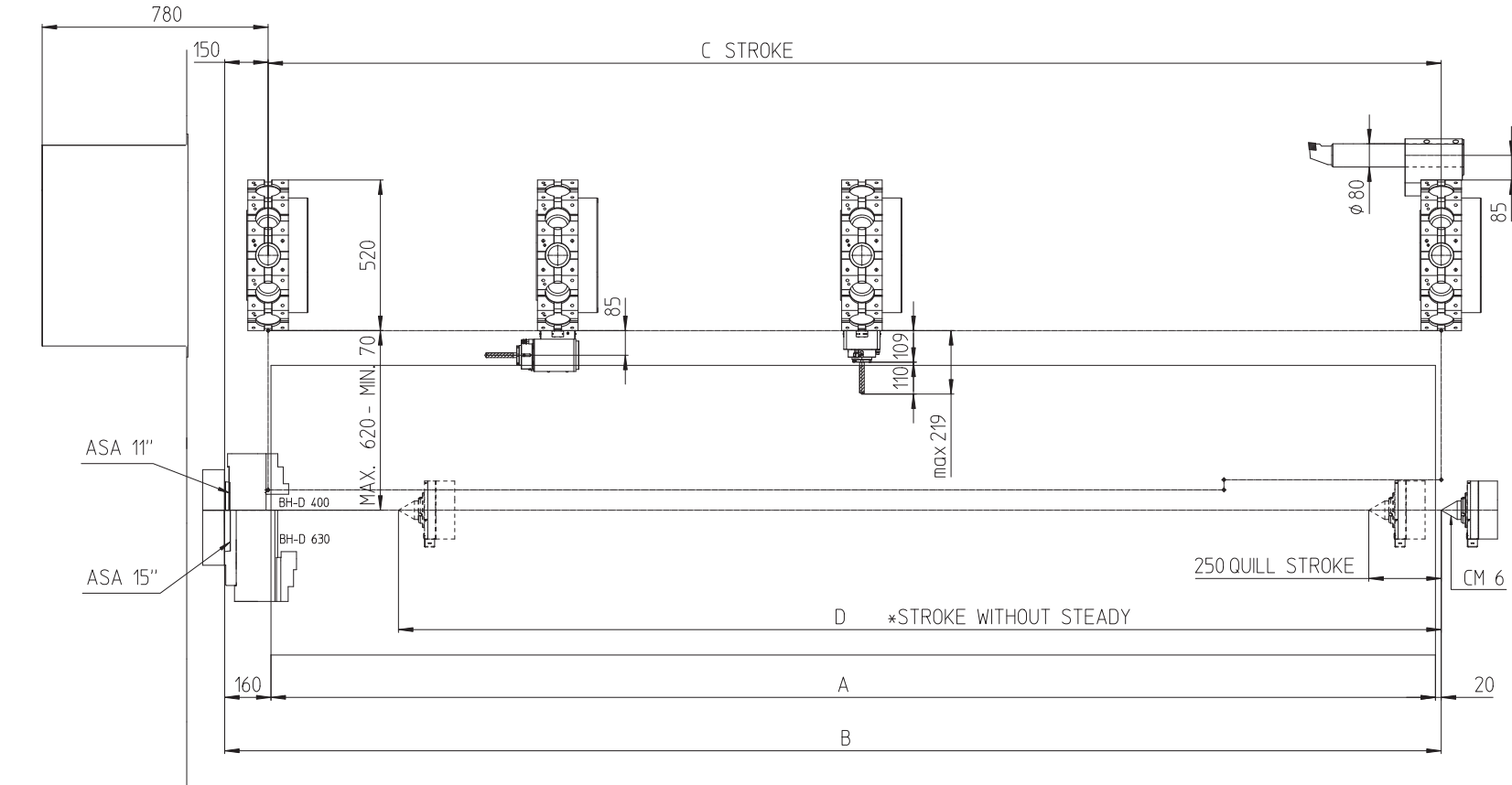

\*Other machine lengths available on request!

D.P.	A	B	C	D
2000	2020	2200	2050	1600
4000	4020	4200	4050	3600
6000	6020	6200	6050	5600

Data indicated in millimetres

# TECHNICAL DATA

## Working area

Swing over bed	Ø 1050 mm
Distance between centres (Spindle nose to center punch tip)	2200 / 4200 / 6200 mm*
Max. turning diameter	Ø 1000 mm
Max. part length	2000 / 4000 / 6000 mm*
Max. workpiece weight (overhung)	1500 kg
Max. workpiece weight between tailstock and chuck (incl. chuck)	6000 kg

## Travel

Carriage travel in X	550 mm
Carriage travel in Z	2050 / 4050 / 6050 mm
Carriage travel in Y	+/- 125 mm

## Main spindle – A2-15" DIN 55026 (ZF gearbox)

Max. speed range	0 – 1800 rpm
Max. capacity, AC hollow spindle motor	84 kW
Max. torque	6410 Nm
Spindle bearing (inner diameter, front)	280 mm
Max. chuck diameter	500 (800) mm

## C-axis

Resolution of the rotary axis	0,001°
Max. torque	5000 N

## Main spindle – counter spindle A2-15" (A2-11") DIN 55026 (ZF gearbox)

Max. speed range	2000 (2500) rpm
Max. capacity	53 kW
Max. torque	4400 Nm
Spindle bearing (inner diameter, front)	
Max. chuck diameter	500 (630) mm

## C-axis with A2-11" spindle

Resolution of the rotary axis	0,001°
Max. torque	2800 N

## Tool mover (standard version)

Number of tool positions (all driven)	12
Tool holder	BMT85 / VDI60

## Tool mover

Speed range	3000 rpm
Drive performance	19,8 kW
Torque	max. 116 Nm

## Feed drives

Rapid traverse speed X / Z / Y	15 / 30 / 30 m/min
Feed force X-axis	30000 N
Feed force Z-axis	30000 N
Feed force Y-axis	20000 N

## Tailstock with quill

Quill stroke	250 mm
Quill diameter	200 mm

## Power consumption

Connected load (15"/11" spindle)	118/86 kVA
----------------------------------	------------

## Dimensions

Height of the rotary axis above floor level	1440 mm
Height of the machine	3360 mm
Footprint W x D BL 2200	8600 x 3450 mm
Footprint W x D BL 4200 / 6200	11100 / 13400 x 3450 mm
Total weight including chip conveyor BL 2200 / 4200 / 6200	ca. 30 / 40 / 50 t

\*optional 1500/3000 bed length





beyond standard /

EMCO GmbH / Salzburger Str. 80 / 5400 Hallein-Taxach / Austria / T +43 6245 891-0 / F +43 6245 86965 / info@emco.at

[www.emco-world.com](http://www.emco-world.com)